

# M-Series

## CIRCUIT BREAKER

The M-Series is a low cost, miniature, hydraulic-magnetic circuit breaker which features a compact, space saving design, front panel snap-in mounting and a vertically mounted parallel pole configuration. It features various styling options to maximize your design flexibility. Choices include rocker, illuminated rocker, paddle and baton style handle actuators, push-to-reset and push-pull pushbutton actuators, as well as Visi-Rocker two color actuators. Our exclusive Rockerguard bezel helps prevent inadvertent actuation and a wiping contact mechanism assures long-term reliability.

The M-Series circuit breakers are available with 1, 2 or parallel poles, 0.02 to 50 amp ratings, and 125 and 250VAC or 80VDC versions. With over 16 different time delays, 5 terminal styles, a variety of panel hardware, various colors, and legend imprinting, it assures suitability for most any application design.



### Resources:

[Download 3D CAD Files](#)

[IGS >](#)

[STP >](#)

### Product Highlights:

- Parallel pole configuration fits in one rack unit
- MIL-PRF-55629
- MIL STD 202 compliant
- MIL-PRF-39019F ingress protection
- Sealed toggle actuator
- Compact design

### Typical Applications:

- Telecom/Datacom
- Transportation
- Marine
- Generators
- Power Supplies
- Medical Equipment



**Carling Technologies®**

Innovative Designs. Powerful Solutions.

**Carling Technologies, Inc.**

60 Johnson Avenue, Plainville, CT 06062

Email: [sales@carlingtech.com](mailto:sales@carlingtech.com)

Application Support: [team2@carlingtech.com](mailto:team2@carlingtech.com)

Phone: 860.793.9281 Fax: 860.793.9231

[www.carlingtech.com](http://www.carlingtech.com)

### Electrical

**Maximum Voltage** 125/250 VAC 50/60 Hz, 80 VDC (See Rating Tables.)

**Current Ratings** Standard current coils: 0.100, 0.250, 0.500, 0.750, 1.00 thru 15.0 in 1 amp increments, 18.0, 20.0, 25.0, 30.0. Other ratings available - see Ordering Scheme.

**Auxiliary Switch Rating** SPDT; 7A 250VAC, 7A (Res) 28VDC, 4A (Ind.) 28VDC, 0.25A 80VDC (Res) (silver contacts), 0.1A 125VAC (gold contacts).

**Insulation Resistance** Minimum of 100 Megohms at 500 VDC.

**Dielectric Strength** UL, CSA 1500V, 50/60 Hz for one minute between all electrically isolated terminals. M-Series Circuit Breakers comply with the 8mm spacing and 3750 V 50/60Hz dielectric requirements from hazardous voltage to operator accessible surfaces, per Publications IEC 380, 435, 950, EN 60950 and VDE 0805.

**Resistance, Impedance** Values from Line to Load Terminal - based on Series Trip Circuit Breaker.

RESISTANCE PER POLE VALUES from Line to Load Terminals (Values Based on Series Trip Circuit Breaker)

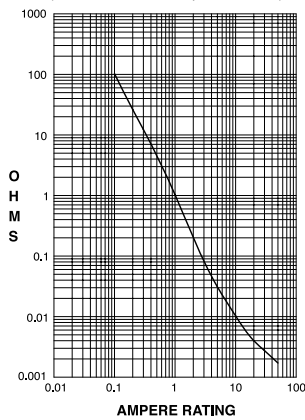

CURRENT (AMPS)	TOLERANCE (%)
0.10 - 20.0	± 25
20.1 - 50.0	± 35

### Pulse Tolerance Curves

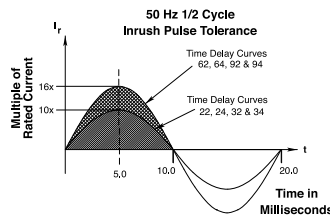
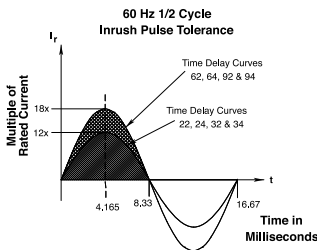

\*Manufacturer reserves the right to change product specification without prior notice.

### Mechanical

**Endurance** 10,000 ON-OFF operations @ 6 per minute with rated Current and Voltage.

**Trip Free** All M-Series Circuit Breakers will trip on overload, even when actuator is forcibly held in the ON position.

**Trip Indication** The actuator moves positively to the OFF position when an overload causes the circuit breaker to trip.

### Physical

**Number of Poles** 1 or 2

**Internal Circuit Configs.** Series with or without Auxiliary Switch. Switch Only with or without Auxiliary Switch.

**Weight** Approximately 30 grams/pole (Approximately 1.07 ounces/pole)

**Standard Colors** See Ordering Scheme

### Environmental

Designed in accordance with requirements of specification MIL PRF-55629 & MIL-STD-202G as follows:

**Shock** Withstands 100 Gs, 6ms, sawtooth while carrying rated current per Method 213, Cond. I. Instantaneous curves tested at 80% of rated current.

**Vibration** Withstands 0.060" excursion from 10-55 Hz, and 10 Gs 55-500 Hz, at rated current per Method 204C, Test Condition A. Instantaneous curves tested at 80% of rated current.

**Moisture Resistance** Method 106D, i.e., ten 24-hour cycles @ + 25°C to +65°C, 80-98% RH.

**Salt Spray** Method 101, Condition A (90-95% RH @ 5% NaCl Solution, 96 hrs).

**Thermal Shock** Method 107D, Condition A (Five cycles @ -55°C to +25°C to +85°C to +25°C).

**Operating Temperature** -40° C to +85° C

**Chemical Resistance** Only the outside surfaces of the case and the handles may be cleaned with detergents or alcohol. Organic (hydrocarbon based) solvents are not recommended because they attack plastics. Caution should be taken when solvents are used to clean and remove flux from terminals. Lubricants should not be introduced into the handle/ bushing openings

## Electrical Tables

**Table A:** Lists UL Recognized and CSA Accepted configurations & performance capabilities as a Component Supplementary Protector.

M-SERIES TABLE A: COMPONENT SUPPLEMENTARY PROTECTORS										
Circuit Configuration	Voltage			Current Rating		Poles Breaking	Short Circuit Capacity (Amps)		Application Codes	
	Max Rating	Frequency	Phase	Full Load Amps	General Purpose Amps		UL / CSA		UL	CSA
							With Backup Fuse	Without Backup Fuse		
Series	32	DC	---	0.02 - 15	---	1	---	1000	TC1, 2, OL1, U1	TC1, 2, OL1, U1
				---	15.1 - 25	1	---	1000	TC1, 2, OL0, U1	TC1, 2, OL0, U1
	50 <sup>2</sup>	DC	---	0.02 - 7.5	---	1	---	1000	TC1, 2, OL0, U1	TC1, 2, OL0, U1
				0.02 - 15	---	2	---	1000	TC1, 2, OL1, U1	TC1, 2, OL1, U1
	65	DC	---	---	15.1 - 25	2	---	1000	TC1, 2, OL0, U1	TC1, 2, OL0, U1
				0.02 - 15	---	1	---	1000	TC1, 2, OL1, U1	TC1, 2, OL1, U1
	65 <sup>1,2</sup>	DC	---	---	15.1 - 30	1	---	1000	TC1, 2, OL0, U1	TC1, 2, OL0, U1
				0.02 - 15	---	2	5000 <sup>3</sup>	---	TC1, 2, OL1, C1	TC1, 2, OL1, C1
	65	DC	---	---	15.1 - 25	2	5000 <sup>3</sup>	---	TC1, 2, OL0, C1	TC1, 2, OL0, C1
				0.02 - 15	---	1	---	600	TC1, 2, OL1, U1	TC1, 2, OL1, U1
	80 <sup>1</sup>	DC	---	---	15.1 - 30	1	---	600	TC1, 2, OL0, U1	TC1, 2, OL0, U1
				0.02 - 15	---	1	---	1000	TC1, 2, OL1, U1	TC1, 2, OL1, U1
	125	50 / 60	1	0.02 - 15	---	1	---	1000	TC1, 2, OL1, U1	TC1, 2, OL1, U1
				---	15.1 - 30	1	---	1000	TC1, 2, OL0, U1	TC1, 2, OL0, U1
1 - 30				---	1	---	360	TC1, OL1, U2	TC3, OL1, U3	
250 <sup>2</sup>	50 / 60	1	0.02 - 12	---	1	---	1000	TC1, 2, OL1, U1	TC1, 2, OL1, U1	
250	50 / 60	1	---	12.1 - 18	1	1000 <sup>4</sup>	---	TC1, 2, OL0, C1	TC1, 2, OL0, C1	
250	50 / 60	1	0.02 - 15	---	2	---	1000	TC1, 2, OL1, U1	TC1, 2, OL1, U1	
			---	15.1 - 30	2	---	1000	TC1, 2, OL0, U1	TC1, 2, OL0, U1	
			1 - 30	---	2	---	360	TC1, OL1, U2	TC3, OL1, U3	

Notes:

- 1 Polarity Sensitive
- 2 Available only with Special Catalog Number. Consult Factory.
- 3 Requires Branch Circuit Backup with a UL Listed type K-5 or RK-5 fuse rated 30 Amps maximum
- 4 Requires Branch Circuit Backup with a UL Listed type K-5 or RK-5 fuse rated 60 Amps maximum

**Table B:** Lists UL Recognized, CSA Accepted and TUV and VDE Certified configurations and performance capabilities as a Component Supplementary Protector.

M-SERIES TABLE B: COMPONENT SUPPLEMENTARY PROTECTORS												
Circuit Configuration	Voltage			Current Rating		Poles Breaking	Short Circuit Capacity (Amps)				Application Codes	
	Max Rating	Frequency	Phase	Full Load Amps	General Purpose Amps		UL / CSA		VDE / TUV		UL	CSA
							With Backup Fuse	Without Backup Fuse	With Backup Fuse	Without Backup Fuse		
Series	32	DC	---	0.02 - 15	---	1	---	1000	3000	500	TC1, 2, OL1, U1	TC1, 2, OL1, U1
				---	15.1 - 25	1	---	1000	3000	500	TC1, 2, OL0, U1	TC1, 2, OL0, U1
	50 <sup>2</sup>	DC	---	0.02 - 7.5	---	1	---	1000	3000	500	TC1, 2, OL0, U1	TC1, 2, OL0, U1
				0.02 - 15	---	2	---	1000	3000	500	TC1, 2, OL1, U1	TC1, 2, OL1, U1
	65	DC	---	---	15.1 - 25	2	---	1000	3000	500	TC1, 2, OL0, U1	TC1, 2, OL0, U1
				0.02 - 15	---	2	5000	---	3000	500	TC1, 2, OL1, C1	TC1, 2, OL1, C1
	65 <sup>3</sup>	DC	---	---	15.1 - 30	2	5000	---	3000	500	TC1, 2, OL0, C1	TC1, 2, OL0, C1
				0.02 - 15	---	1	---	600 <sup>4</sup>	---	500	TC1, 2, OL1, U1	TC1, 2, OL1, U1
	80 <sup>1</sup>	DC	---	---	15.1 - 30	1	---	600 <sup>4</sup>	---	500	TC1, 2, OL0, U1	TC1, 2, OL0, U1
				0.02 - 15	---	1	---	1000	3000	500	TC1, 2, OL1, U1	TC1, 2, OL1, U1
	125	50 / 60	1	0.02 - 15	---	1	---	360	3000	500	TC1, OL1, U2	TC3, OL1, U3
				1 - 15	---	1	---	1000	3000	500	TC1, 2, OL1, U1	TC1, 2, OL1, U1
	250	50 / 60	1	0.02 - 12	---	1	---	1000	3000	500	TC1, 2, OL1, U1	TC1, 2, OL1, U1
				0.02 - 20	---	2	---	1000	3000	500	TC1, 2, OL0, U1	TC1, 2, OL0, U1
1 - 12				---	1	---	360	3000	500	TC1, OL1, U2	TC3, OL1, U3	

Notes:

- 1 Polarity Sensitive
- 2 Available only with Special Catalog Number. Consult Factory.
- 3 Requires Branch Circuit Backup with a UL Listed type K-5 or RK-5 fuse rated 30 Amps maximum
- 4 TUV only, not VDE
- 5 Requires backup protection with a thermal magnetic circuit breaker rated 32 amps and having a Type C trip characteristic per EN60898/DIN VDE 0641 (C32A) for ratings greater than 15amps, and a thermal magnetic circuit breaker rated 16 amps and having a Type C trip characteristic per EN60898/DIN VDE 0641 (C16A) for ratings 15 amps and less

## Electrical Tables

**Table C:** Lists UL489A Listed and TUV Certified configurations and performance capabilities for use in Communications Equipment.

M-SERIES TABLE C: UL489A Listed (Communications Equipment - Polarity Sensitive)						
Circuit Configuration	Voltage		Current Rating General Purpose Amps	Poles Breaking	Interrupting Capacity (Amps)	
	Max Rating	Frequency			Without Backup Fuse	
					UL489A	TUV
Series	80	DC	0.02 - 30	1	600	---
	65 <sup>1</sup>	DC	0.02 - 30	1	1000	---
	80	DC	0.10 - 30	1	600	600

Notes:

1. Available only with Special Catalog Number

**Table D:** Lists UL489A Listed configurations and performance capabilities for use in Communications Equipment.

M-SERIES TABLE D: Parallel Pole Construction UL489A Listed (Communications Equipment - Polarity Sensitive)						
Circuit Configuration	Voltage		Current Rating General Purpose Amps	Poles Breaking	Interrupting Capacity (Amps)	
	Max Rating	Frequency			Without Backup Fuse	
					UL489A	
Series	80	DC	31 - 50	2	600	
	65 <sup>1</sup>	DC	31 - 50	2	1000	

Notes:

1. Available only with Special Catalog Number

## Agency Certifications

### UL Recognized

UL Standard 1077



Component Recognition Program as Protectors, Supplementary (Guide CCN/QVNU2, File E75596)

### CSA Accepted



Component Supplementary Protector (Class 3215 30, File 047848 0 000) CSA Standard C22.2 No. 235

### UL Listed

UL Standard 489A



Communications Equipment (Guide CCN/DITT, File E189195)

### VDE Certified



EN60934, VDE 0642 under File 10537

### TUV Certified



EN60934, under License No. R9671109

**M** **E** **2** - **P** - **D2** - **650** - **5** - **A** **1** **2** - **B** - **T**

1 Series    2 Actuator    3 Poles    4 Circuit    5 Frequency & Delay    6 Current Rating    7 Terminal    8 Illumination    9 Actuator Color & Legend    10 Legend    11 Bezel Color    12 Agency Approval

**1 SERIES**  
M

**2 ACTUATOR**

**Single Color**  
A Angled  
B Flat

**Two Color Visi**  
D Indicate ON  
E Indicate OFF

**Single Color Translucent**  
F Angled  
G Flat

STYLE	INDICATE - "ON" (CODE-D)	INDICATE - "OFF" (CODE-E)	FLAT (CODES-B & G)	ANGLED (CODES-A & F)
VERTICAL				
HORIZONTAL				

**3 POLES**  
2 Two

**4 CIRCUIT/AUXILIARY SWITCH <sup>2</sup>**  
**P** Series Trip Current (Parallel Pole)  
**with Auxiliary Switch, Silver Contacts**  
**Q** Series Trip Current (Parallel Pole) .110 x 0.20 Q.C  
**with Auxiliary Switch, Gold Contacts**  
**R** Series Trip Current (Parallel Pole) .110 x 0.20 Q.C

**5 FREQUENCY & TIME DELAY**  
**D2** DC Short  
**D4** DC Medium

**6 CURRENT RATING (AMPERES)**

CODE	AMPERES
631	31.000
635	35.000
640	40.000
645	45.000
650	50.000

**7 TERMINAL**  
**A** Push in Stud  
**5** 10-32 Screw (Bus Type)

**8 ILLUMINATION**  
**Non-Illuminated**  
**A** Non-Illuminated

**9 ACTUATOR COLOR & LEGEND**

	Actuator Visi <sup>1</sup>	Legend
1	White	Black
2	Black	White
3	Red	White
4	Green	White
5	Blue	White
6	Yellow	Black
7	Gray	Black
8	Orange	Black

**10 LEGEND**  
**2** ON - OFF Vertical  
**3** ON - OFF Horizontal  
**6** Dual Vertical  
**7** Dual Horizontal

**11 BEZEL COLOR**  
**A** White without Rockerguard  
**B** Black without Rockerguard  
**G** Gray without Rockerguard  
**1** White with Rockerguard  
**2** Black with Rockerguard  
**7** Gray with Rockerguard

**12 AGENCY APPROVAL**  
**T** UL 489A Listed

Notes:  
 1 Reminder of Rocker same color as Visi  
 2 Aux Switch only available with screw terminals



**1 SERIES**  
M

**2 ACTUATOR**  
M Paddle  
T Push-Pull

**3 POLES**  
2 Two

**4 CIRCUIT/AUXILIARY SWITCH <sup>1</sup>**  
**P** Series Trip Current (Parallel Pole)  
**with Auxiliary Switch, Silver Contacts**  
**Q** Series Trip Current (Parallel Pole) .110 x 0.20 Q.C  
**with Auxiliary Switch, Gold Contacts**  
**R** Series Trip Current (Parallel Pole) .110 x 0.20 Q.C

**5 FREQUENCY & TIME DELAY**  
**D2** DC Short  
**D4** DC Medium

**6 CURRENT RATING (AMPERES)**

CODE	AMPERES
631	31.000
635	35.000
640	40.000
645	45.000
650	50.000

**7 TERMINAL**  
**A** Push in Stud  
**5** 10-32 Screw (Bus Type)

**8 ACTUATOR COLOR & LEGEND**

Handle		Push Button	
1	White	A	White
2	Black	B	Black
3	Red	C	Red
4	Green	D	Green
5	Blue	E	Blue
6	Yellow	F	Yellow
7	Gray	G	Gray
8	Orange	H	Orange

**9 FRONT PANEL HARDWARE**

**Handle**

- A No outer Panel Hardware
- B Knurled Nut, Bright Nickel
- C Knurled Nut, Bright Nickel with Locking Ring
- D Knurled Nut, Black
- E Knurled Nut, Black with Locking Ring
- F Panel Dress, Bright Nickel
- G Panel Dress, Bright Nickel with Locking Ring
- H Panel Dress, Black
- J Panel Dress, Black with Locking Ring

**Push Button**

- 1 No outer Panel Hardware
- 2 Knurled Nut, Bright Nickel

**10 LEGEND PLATE / BUTTON MARKING**

**Handle Actuator Legend Plate**

- B** ON - OFF Vertical
- C** ON - OFF Horizontal

**Push-Pull Actuator Legend Plate**

- 2** Rated Amps Horizontal
- 3** Rated Amps Line Side Down
- 4** Rated Amps Line Side Up

**11 BUSHING COLOR**  
**B** Black

**12 AGENCY APPROVAL**  
**T** UL 489A Listed

Notes:  
 1 Aux Switch only available with screw terminals

## Dimensional Specifications: in. [mm]

### PARALLEL POLE TERMINAL OPTIONS

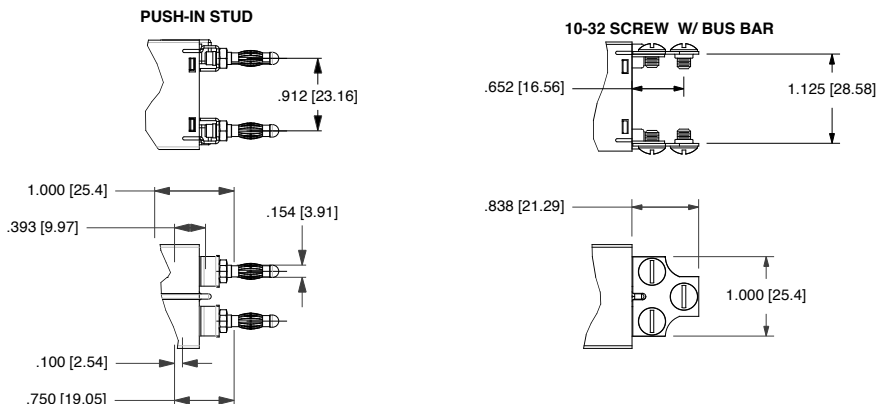

### ROCKER ACTUATOR DETAIL

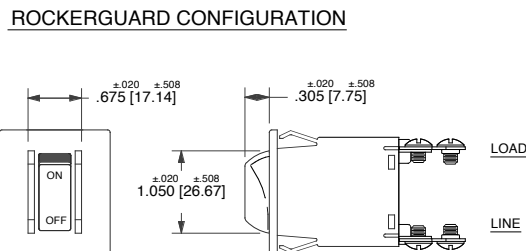
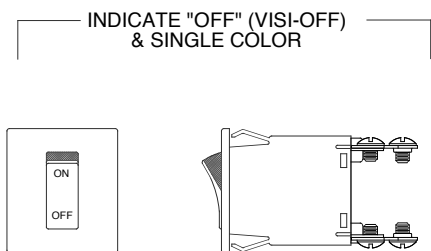
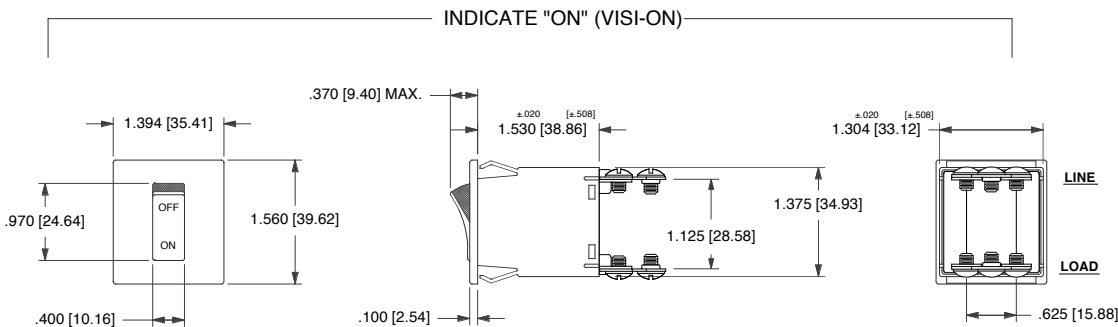

### PANEL CUT - OUT DETAIL (ROCKER)

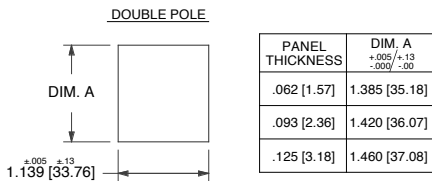

Notes:

- 1 All dimensions are in inches [millimeters].
- 2 Tolerance  $\pm .010$  [25] unless otherwise specified.
- 3 Dimensions apply to both rocker styles.
- 4 I-o, on-off or dual legends available for vertical or horizontal mounting.
- 5 Notice that circuit breaker line and load terminal orientation on indicate "off" is opposite that of indicate "on".

## Dimensional Specifications: in. [mm]

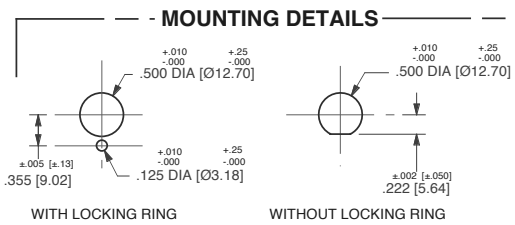
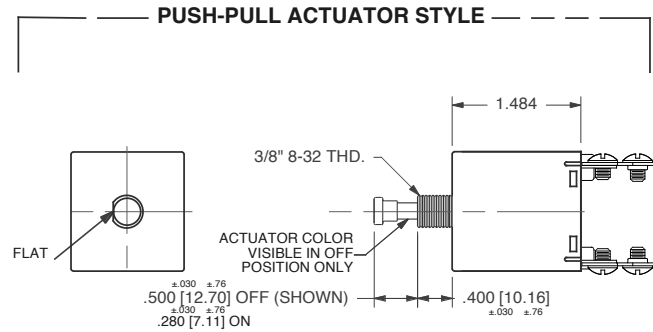
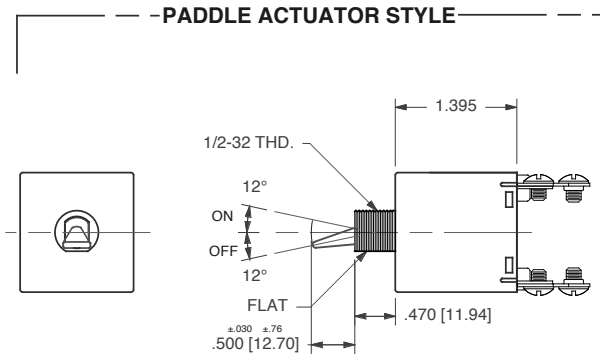

**MOUNTING DETAILS**

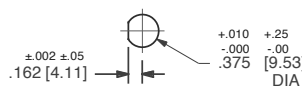

**PUSH-PULL, PUSH TO RESET**



**SNAP-IN BUSHING**

**PANEL HARDWARE**

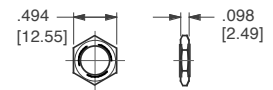

**HEX NUT**

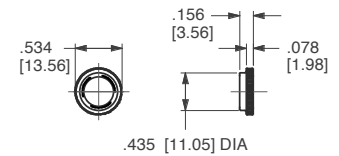

**PANEL DRESS NUT**

**LEGEND PLATES**

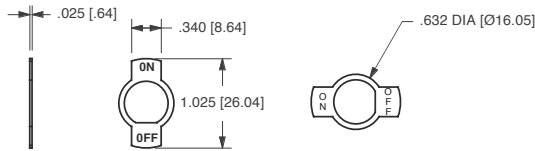

LEGEND CODE:

B

C

**BUTTON MARKING ORIENTATION**

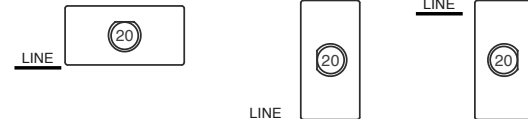

MARKING CODE:

2

3

4

**PANEL HARDWARE**

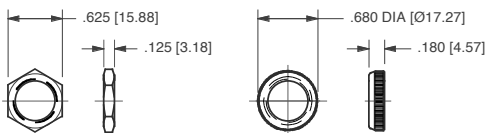

**HEX NUT**

**PANEL DRESS NUT**

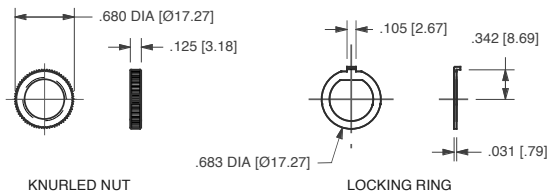

**KNURLED NUT**

**LOCKING RING**

**.110QC AUXILIARY SWITCH TERMINALS**

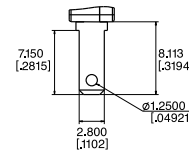

Notes:



- All dimensions are in inches [millimeters].
- Tolerance ±.010 [.25] unless otherwise specified.
- Dimensions apply to both rocker styles.
- I-o, on-off or dual legends available for vertical or horizontal mounting.
- Notice that circuit breaker line and load terminal orientation on indicate "off" is opposite that of indicate "on".

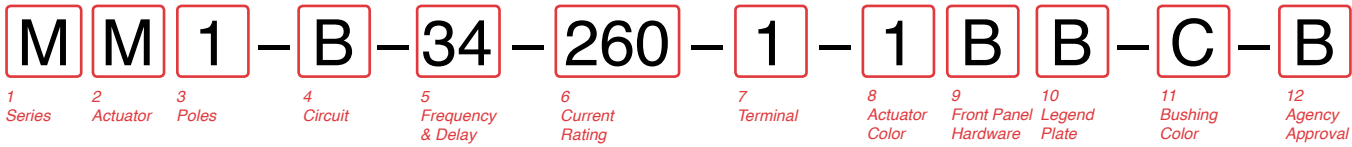





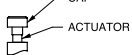

**1 SERIES**  
M

**2 ACTUATOR <sup>1</sup>**

**Handle**  
M Paddle  N Baton 

**Push Button**  
T Push-Pull  U Push To Reset 

**Push Button with Snap-In Mounting**  
V Push-Pull  W Push To Reset 

**3 POLES**  
1 One 2 Two

**4 CIRCUIT <sup>2</sup>**  
**without Auxiliary Switch**  
A Switch Only (no coil), Maintained Contacts  
B Series Trip (Current)  
**with Auxiliary Switch, Silver Contacts**  
M Series Trip (Current) Aux Switch  
P<sup>3</sup> Switch Only, Maintained Contacts  
Q<sup>3,4</sup> Switch Only, Maintained Contacts  
R<sup>3,13</sup> Switch Only, Maintained Contacts  
S<sup>3</sup> Series Trip (Current)  
T<sup>3,4</sup> Series Trip (Current)  
U<sup>3,13</sup> Series Trip, Maintained Contacts  
**with Auxiliary Switch, Gold Contacts**  
2<sup>3,4</sup> Switch Only, Maintained Contacts  
3<sup>3,13</sup> Switch Only, Maintained Contacts  
4<sup>3,4</sup> Series Trip (Current)  
5<sup>3,13</sup> Series Trip, Maintained Contacts  
9 Series Trip (Current) Aux Switch

**Terminal Type:**  
.110 QC x .020 QC  
.060 Dia, Round Solder Turret  
.058 Dia, Round Q.C.  
.080 Dia x .020 Flat Q.C.  
.060 Dia, Round Solder Turret  
.058 Dia, Round Q.C.  
.080 Dia x .020 Flat Q.C.  
.058 Dia, Round Q.C.  
.080 Dia x .020 Flat Q.C.  
.058 Dia, Round Q.C.  
.080 Dia x .020 Flat Q.C.  
.110 QC x .020 QC

**5 FREQUENCY & DELAY**

03	DC	50/60Hz	Switch Only	32	DC, 50/60Hz Short
10	DC	Instantaneous		34	DC, 50/60Hz Medium
12	DC	Short		62	50/60Hz Short, Hi-Inrush
14	DC	Medium		64	50/60Hz Medium, Hi-Inrush
20	50/60Hz	Instantaneous		72	DC, Short, Hi-Inrush
22	50/60Hz	Short		74	DC, Medium, Hi-Inrush
24	50/60Hz	Medium		92	DC, 50/60Hz Short, Hi-Inrush
30	DC, 50/60Hz	Instantaneous		94	DC, 50/60Hz Medium, Hi-Inrush

Voltage			Full Load Amp Rating		General Purpose Amps		Tungsten Lamp Rating		Poles Breaking
Max Rating	Frequency	Phase	Max Amps	Choose Current Coil Rating Code	Max Amps	Choose Current Coil Rating Code	Max Amps	Choose Current Coil Rating Code	
32	DC	-	15	615	25	625	-	-	1
50	DC	-	-	-	7.5	Consult Factory	-	-	1
65	DC	1	15	615	25	625	-	-	2
125	50/60Hz	1	15	615	25	625	15	615	1
250	50/60Hz	1	12	612	-	-	-	-	1
250	50/60Hz	1	15	615	25	625	-	-	2

- Notes:
- One actuator is located in the center of each multi-pole breaker. Actuator codes V & W limited to single pole breakers only.
  - Switch Only circuits are not available with Push-To-Reset actuators. For Switch Only circuits, select Current Coil Rating from the above chart.
  - One Auxiliary Switch is supplied per breaker. On two-pole breakers, standard Auxiliary Switch mounting is in pole one. Auxiliary Switch option limited to Series Trip and Switch Only circuits. Not available with back connect screw or push-in stud terminals.
  - Mates with AMP .058" diameter pin receptacles including 60983-1 (gold plated) and 60983-2 (tin plated).
  - Actuator color is only visible in the OFF position on Push-Pull actuators.
  - All units except snap-in mounting have one hex nut installed on bushing for use behind the panel.
  - Other colors available. Consult factory.
  - TUV 20A, VDE 15A. UL Recognized and CSA Accepted to 30 amps. Screw Terminals or Push-in Stud recommended above 20 amps.
  - 30 amp rating not available with delay's 30, 32, 34, 92 or 94.
  - Screw Terminals are VDE certified only with use of ring terminal attached to wire.
  - Terminal code A available with circuit codes A & B only.
  - Printed circuit board available with UL recognized approval only.
  - Auxiliary switch (flat Q.C.) available with UL recognized approvals only.

**6 CURRENT RATING (AMPERES)**

CODE	AMPERES						
020	0.020	225	0.250	420	2.000	710	10.500
025	0.025	230	0.300	522	2.250	611	11.000
030	0.030	235	0.350	425	2.500	711	11.500
035	0.035	240	0.400	527	2.750	612	12.000
040	0.040	245	0.450	430	3.000	712	12.500
045	0.045	250	0.500	435	3.500	613	13.000
050	0.050	255	0.550	440	4.000	614	14.000
055	0.055	260	0.600	445	4.500	615	15.000
060	0.060	265	0.650	450	5.000	616	16.000
065	0.065	270	0.700	455	5.500	617	17.000
070	0.070	275	0.750	460	6.000	618	18.000
075	0.075	280	0.800	465	6.500	620	20.000
080	0.080	285	0.850	470	7.000	622	22.000
085	0.085	290	0.900	475	7.500	624	24.000
090	0.090	295	0.950	480	8.000	625	25.000
090	0.095	410	1.000	485	8.500	630	30.000 <sup>9</sup>
210	0.100	512	1.250	490	9.000		
215	0.150	415	1.500	495	9.500		
220	0.200	517	1.750	610	10.000		

**7 TERMINAL**

1	Push-On 0.250 Tab (Q.C.)	A <sup>11</sup>	Push-In Stud
2 <sup>10</sup>	Screw 8-32 with Upturned Lugs	P <sup>12</sup>	Printed Circuit Board
3 <sup>10</sup>	Screw 8-32 (Bus Type)		

**8 ACTUATOR COLOR & LEGEND <sup>5</sup>**

Gloss Handle	Push-Button	Actuator Color
1	A	White
2	B	Black
3	C	Red
4	D	Green
5	E	Blue
6	F	Yellow
8	H	Orange

**9 FRONT PANEL HARDWARE <sup>6</sup>**

	Handle	Push-Button
No outer Panel Hardware	A	1
<b>Knurled Nut</b>		
Bright nickel	B	2
Bright nickel with locking ring	C	
Black	D	
Black with locking ring	E	
<b>Panel Dress Nut</b>		
Bright nickel	F	
Bright nickel with locking ring	G	
Black	H	
Black with locking ring	J	

**10 LEGEND PLATE / BUTTON MARKING**

**Handle Actuator Legend Plate (Actuator Styles M & N)**  
A No Legend Plate  
B ON - OFF Vertical  
C ON - OFF Horizontal  
D I - O Vertical  
E I - O Horizontal

**Push-Pull Actuator Button Cap (Actuator Styles T & V)**  
1 No Marking  
2 Rated Amps Horizontal  
3 Rated Amps Line Side Down  
4 Rated Amps Line Side Up

**Push-to-Reset Actuator Button (Actuator Styles U & W)**  
1 No Marking



**11 BUSHING COLOR <sup>7</sup>**  
B Black

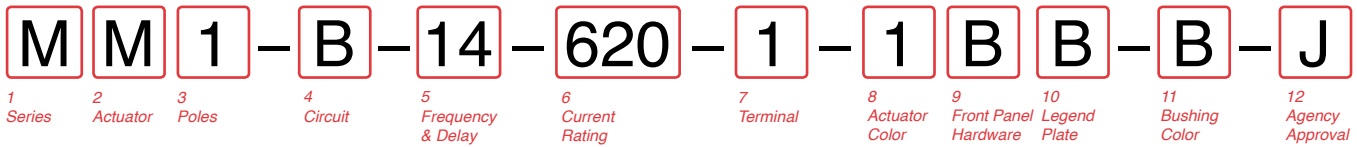

**12 AGENCY APPROVAL <sup>8</sup>**  
C UL Recognized & CSA Accepted  
D VDE Certified, UL Recognized & CSA Accepted  
E TUV Certified, UL Recognized & CSA Accepted



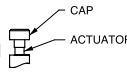

**1 SERIES**  
M

**2 ACTUATOR <sup>1</sup>**

**Handle**  
M Paddle  N Baton 

**Push Button**  
T Push-Pull  U <sup>8</sup> Push To Reset 

**Push Button with Snap-In Mounting**  
V Push-Pull  W <sup>8</sup> Push To Reset 

**3 POLES**  
1 One

**4 CIRCUIT**

**without Auxiliary Switch**  
B Series Trip (Current)

**with Auxiliary Switch, Silver Contacts**  
M Series Trip (Current) Aux Switch  
S <sup>3</sup> Series Trip (Current)  
T <sup>3,4</sup> Series Trip (Current)  
U <sup>3,13</sup> Series Trip, Maintained Contacts

**with Auxiliary Switch, Gold Contacts**  
4 <sup>2,3</sup> Series Trip (Current)  
5 <sup>3,12</sup> Series Trip, Maintained Contacts  
9 Series Trip (Current) Aux Switch

**Terminal Type:**  
.110 QC x .020 QC  
.060 Dia, Round Solder Turret  
.058 Dia, Round Q.C.  
.080 Dia x .020 Flat Q.C.  
.058 Dia, Round Q.C.  
.080 Dia x .020 Flat Q.C.  
.110 QC x .020 QC

**5 FREQUENCY & DELAY**

10 DC Instantaneous	72 DC, Short, Hi-Inrush
12 DC Short	74 DC, Medium, Hi-Inrush
14 DC Medium	

**6 CURRENT RATING (AMPERES)**

CODE	AMPERES				
020	0.020	225	0.250	420	2.000
025	0.025	230	0.300	522	2.250
030	0.030	235	0.350	425	2.500
035	0.035	240	0.400	527	2.750
040	0.040	245	0.450	430	3.000
045	0.045	250	0.500	435	3.500
050	0.050	255	0.550	440	4.000
055	0.055	260	0.600	445	4.500
060	0.060	265	0.650	450	5.000
065	0.065	270	0.700	455	5.500
070	0.070	275	0.750	460	6.000
075	0.075	280	0.800	465	6.500
080	0.080	285	0.850	470	7.000
085	0.085	290	0.900	475	7.500
090	0.090	295	0.950	480	8.000
090	0.095	410	1.000	485	8.500
210	0.100	512	1.250	490	9.000
215	0.150	415	1.500	495	9.500
220	0.200	517	1.750	610	10.000

**7 TERMINAL <sup>4</sup>**

1 Push-On 0.250 Tab (Q.C.)	A <sup>10</sup> Push-In Stud
2 Screw 8-32 with Upturned Lugs	P <sup>11</sup> Printed Circuit Board
3 Screw 8-32 (Bus Type)	

**8 ACTUATOR COLOR & LEGEND <sup>5</sup>**

Gloss Handle	Push-Button	Actuator Color
1	A	White
2	B	Black
3	C	Red
4	D	Green
5	E	Blue
6	F	Yellow
8	H	Orange

**9 FRONT PANEL HARDWARE <sup>6</sup>**

No outer Panel Hardware	Handle	Push-Button
<b>Knurled Nut</b>	A	1
Bright nickel	B	2
Bright nickel with locking ring	C	
Black	D	
Black with locking ring	E	
<b>Panel Dress Nut</b>	F	
Bright nickel	G	
Bright nickel with locking ring	H	
Black	J	
Black with locking ring		

**10 LEGEND PLATE / BUTTON MARKING**

**Handle Actuator Legend Plate (Actuator Styles M & N)**

A No Legend Plate  
B ON - OFF Vertical  
C ON - OFF Horizontal  
D I - O Vertical  
E I - O Horizontal

**Push-Pull Actuator Button Cap (Actuator Styles T & V)**

1 <sup>8</sup> No Marking  
2 Rated Amps Horizontal  
3 Rated Amps Line Side Down  
4 Rated Amps Line Side Up

**Push-to-Reset Actuator Button (Actuator Styles U & W)**

1 <sup>8</sup> No Marking

**11 BUSHING COLOR <sup>7</sup>**

B Black

**12 AGENCY APPROVAL <sup>9</sup>**

J UL489A Listed, TUV Certified  
M UL Recognized, CSA Accepted  
N UL Recognized, TUV Certified  
T UL489A Listed

1 One actuator is located in the center of each multi-pole breaker. Actuator codes V & W limited to single pole breakers only.  
2 One Auxiliary Switch is supplied per breaker. On two-pole breakers, standard Auxiliary Switch mounting is in pole one. Auxiliary Switch option limited to Series Trip and Switch Only circuits. Not available with Back Connected Screw or Push-in Stud terminals.  
3 Mates with AMP .058" diameter pin receptacles including 60983-1 (gold plated) and 60983-3 (tin plated).  
4 Screw terminals or Push-in Stud recommended above 20 amps.  
5 Actuator color is only visible in the OFF position on Push-Pull actuators.  
6 All units have one hex nut installed on bushing for use behind the panel.  
7 Other colors available. Consult factory.  
8 Not available with UL489A Listed breakers.  
9 UL Recognized, CSA Accepted and UL Listed to 30 amps.  
10 Terminal code A available with circuit codes A & B only.  
11 Printed circuit board available with UL recognized approval only.  
12 Auxiliary switch (flat Q.C.) available with UL recognized approvals only.

# Circuit & Terminal Diagrams: in. [mm]

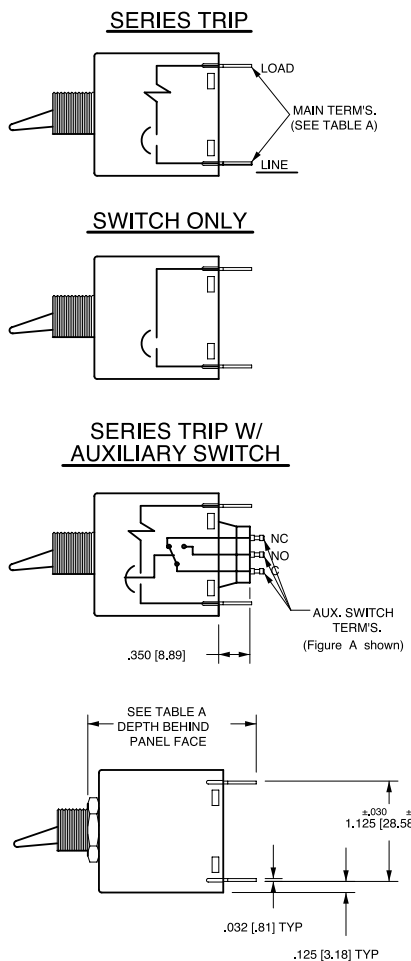

TABLE A		DEPTH BEHIND PANEL FACE *
TERMINAL DESCRIPTION		
MAIN	TAB (Q.C)	1.890 [48.00]
	SCREW (#8-32)	1.930 [49.03]
	PUSH-IN STUD	2.520 [64.00]
AUX. ** SWITCH	DOUBLE SOLDER TURRET TYPE	2.035 [51.68]
	ROUND Q.C TYPE	2.025 [51.44]
	FLAT QUICK-CONNECT	2.129 [54.08]
	FLAT SOLDER LUG	2.012 [51.10]

\*DEPTH INCLUDES BEHIND PANEL HEX NUT AS SUPPLIED ON ALL UNITS.

\*\* WHEN CALLED FOR ON MULTI-POLE UNITS, ONLY ONE AUX. SWITCH IS NORMALLY SUPPLIED, MOUNTED AS SHOWN IN FIG. A

## MULTI-POLE IDENTIFICATION SCHEME

SOLDER TURRET AND ROUND QC AUX SWITCH TERMINALS

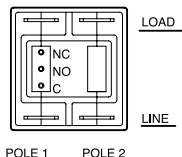

FIG. A

FLAT QC AND SOLDER LUG AUX SWITCH TERMINALS

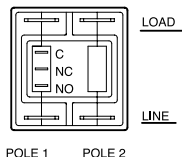
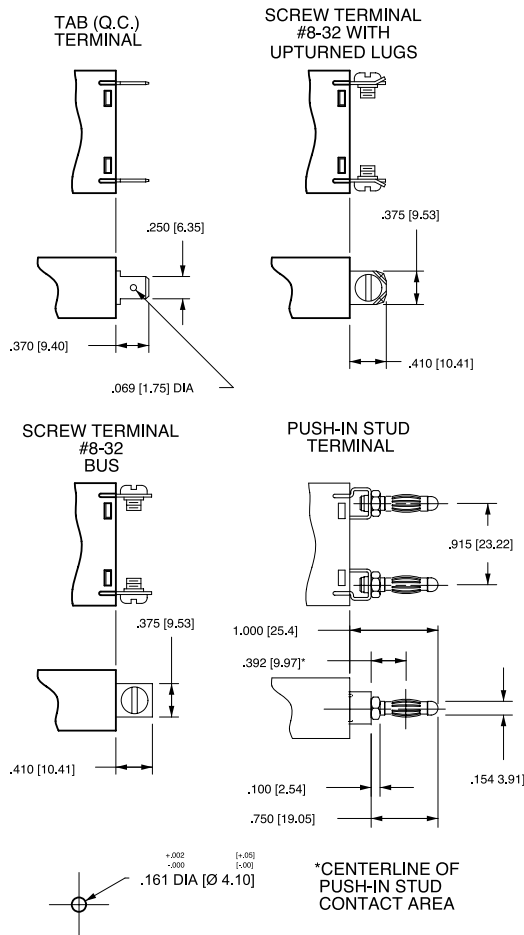
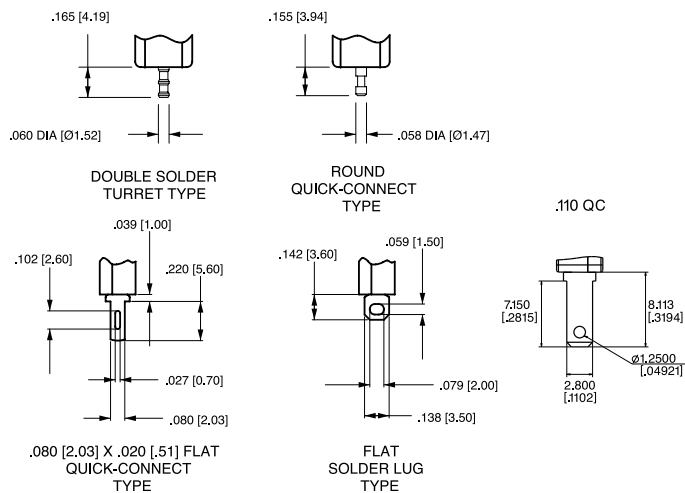

FIG. B

## TERMINAL DIMENSIONAL DETAIL



## AUXILIARY SWITCH TERMINALS



Notes:

- All dimensions are in inches [millimeters].
- Tolerance ±.020 [.51] unless otherwise specified.

## PC Terminal Diagrams: in. [mm]

### HANDLE TYPE SHOWN WITHOUT AUX. SWITCH

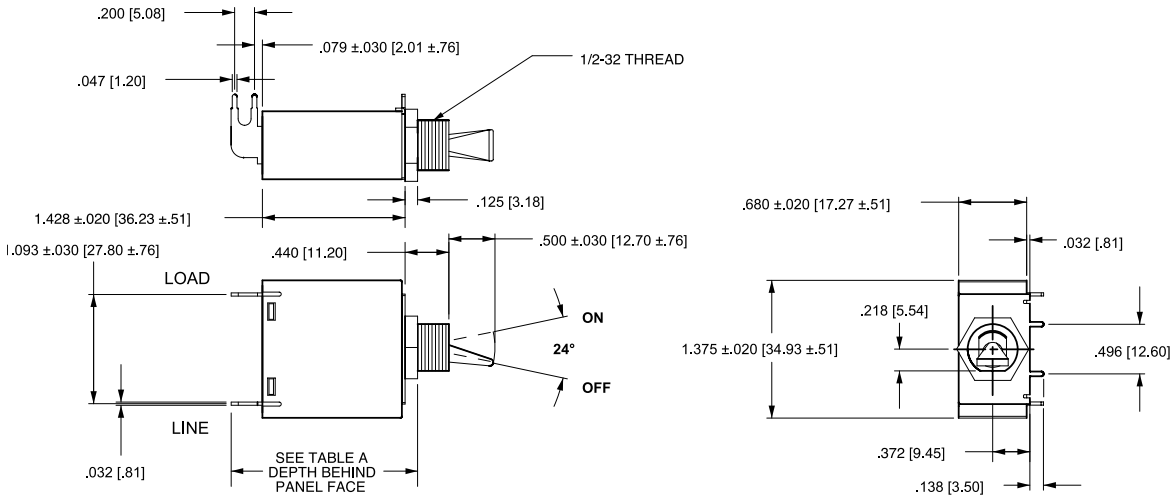

### P.C. FOOTPRINT

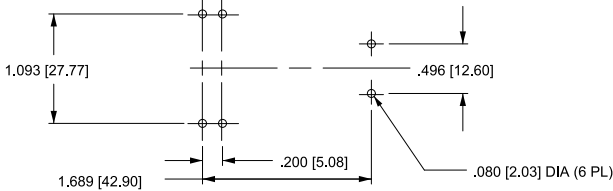

### P.C. TERMINAL

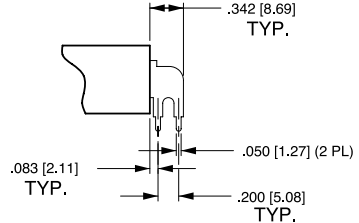

### HANDLE TYPE SHOWN WITH AUX. SWITCH

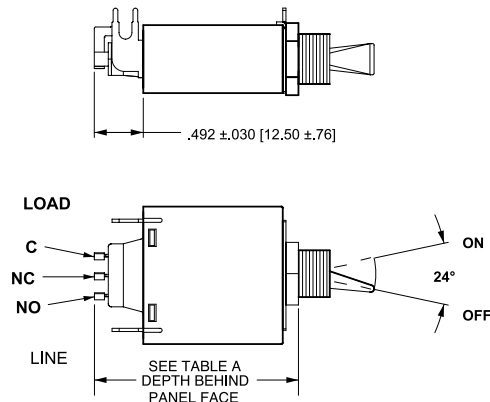

### P.C. FOOTPRINT

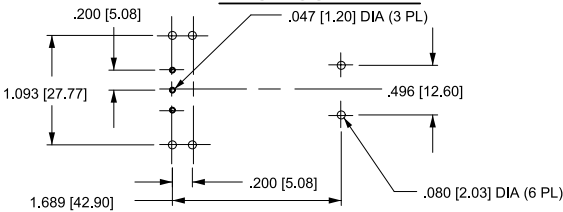

### PANEL HARDWARE

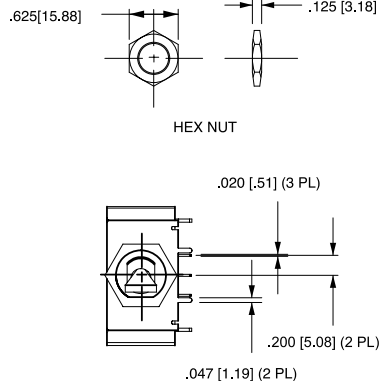

TABLE A		
	TERMINAL DESCRIPTION	DEPTH BEHIND PANEL FACE *
MAIN	PRINTED CIRCUIT BOARD	1.957 [49.71]
AUX. SWITCH	PRINTED CIRCUIT BOARD	2.449 [62.20]

\*DEPTH INCLUDES BEHIND PANEL HEX NUT AS SUPPLIED ON ALL UNITS

- Notes:  
 1 All dimensions are in inches [millimeters].  
 2 Tolerance ±.020 [.51] unless otherwise specified.

## Dimensional Specifications: in. [mm]

### PADDLE ACTUATOR STYLE

#### SINGLE POLE

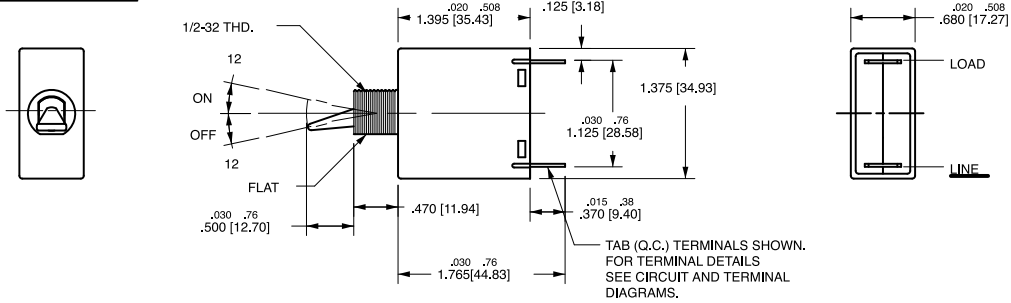

#### DOUBLE POLE

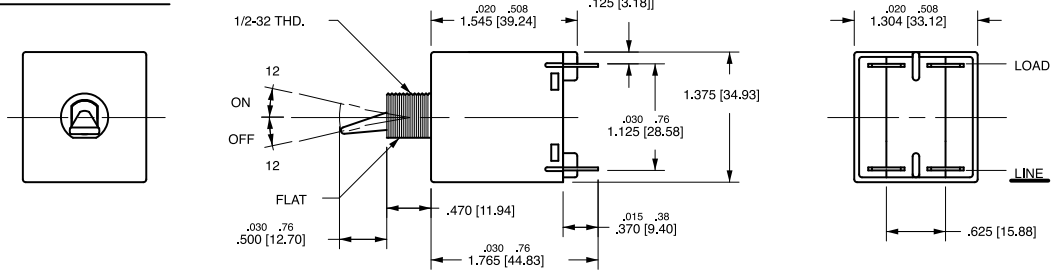

### BATON ACTUATOR STYLE

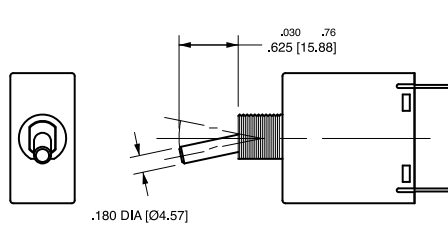

### MOUNTING DETAILS

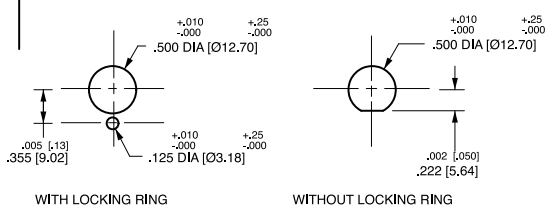

### LEGEND PLATES

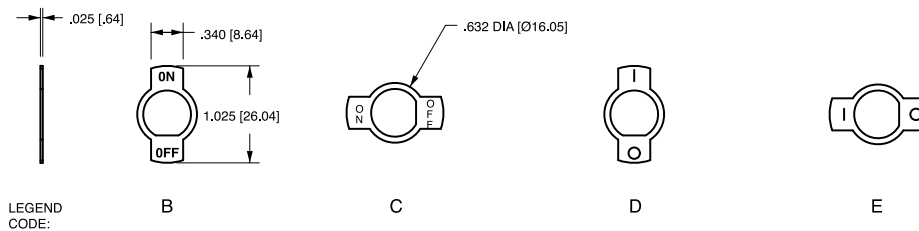

### PANEL HARDWARE

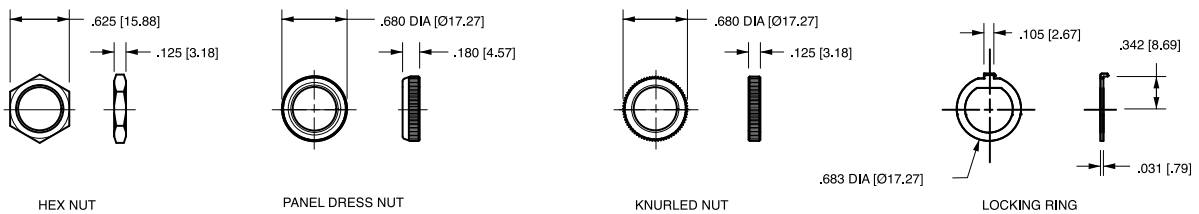

Notes:

- 1 All dimensions are in inches [millimeters].
- 2 Tolerance  $\pm 0.020$  [.51] unless otherwise specified.

## Circuit & Terminal Diagrams: in. [mm]

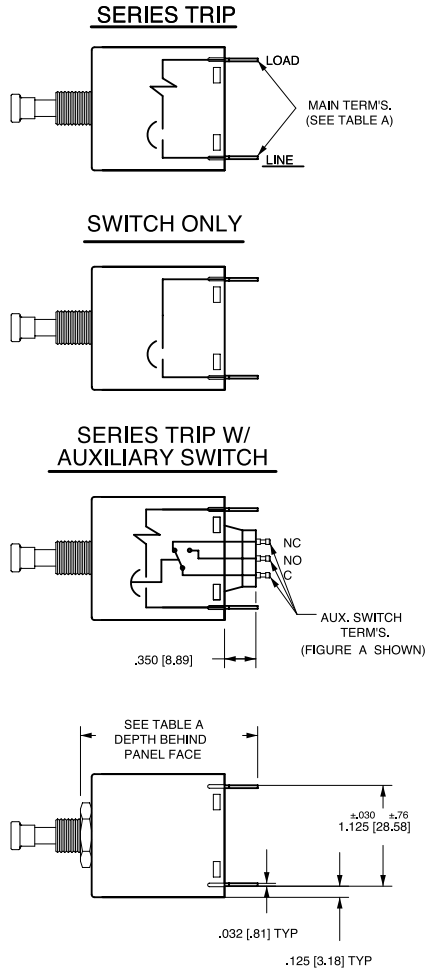

TERMINAL DESCRIPTION		DEPTH BEHIND PANEL FACE *
MAIN	TAB (Q.C.)	1.952 [49.57]
	SCREW (#8-32)	1.992 [50.60]
	PUSH-IN STUD	2.582 [65.58]
AUX. ** SWITCH	DOUBLE SOLDER TURRET TYPE	2.097 [53.26]
	ROUND Q.C. TYPE	2.087 [53.01]
	FLAT QUICK-CONNECT	2.191 [55.65]
	FLAT SOLDER LUG	2.074 [52.68]

\*DEPTH INCLUDES BEHIND PANEL HEX NUT AS SUPPLIED ON ALL UNITS.

\*\*WHEN CALLED FOR ON MULTI-POLE UNITS, ONLY ONE AUX. SWITCH IS NORMALLY SUPPLIED, MOUNTED AS SHOWN IN FIG. A

### MULTI-POLE IDENTIFICATION SCHEME

SOLDER TURRET AND ROUND QC AUX SWITCH TERMINALS

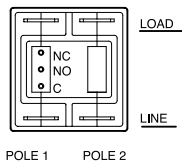

FIG. A

FLAT QC AND SOLDER LUG AUX SWITCH TERMINALS

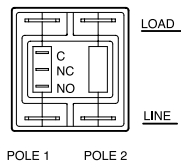
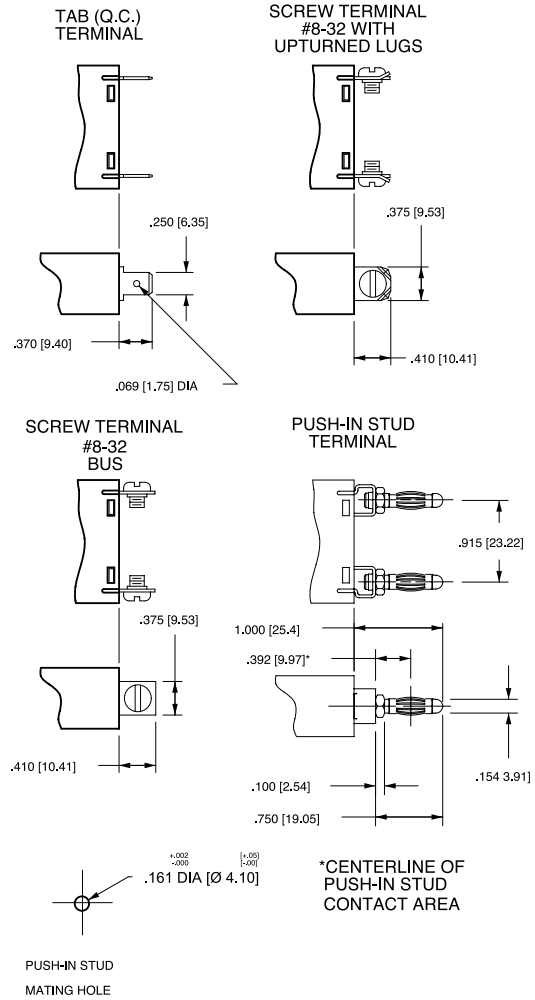

FIG. B

Notes:

- All dimensions are in inches [millimeters].
- Tolerance  $\pm .020$  [.51] unless otherwise specified.

### TERMINAL DIMENSIONAL DETAIL



### AUXILIARY SWITCH TERMINALS

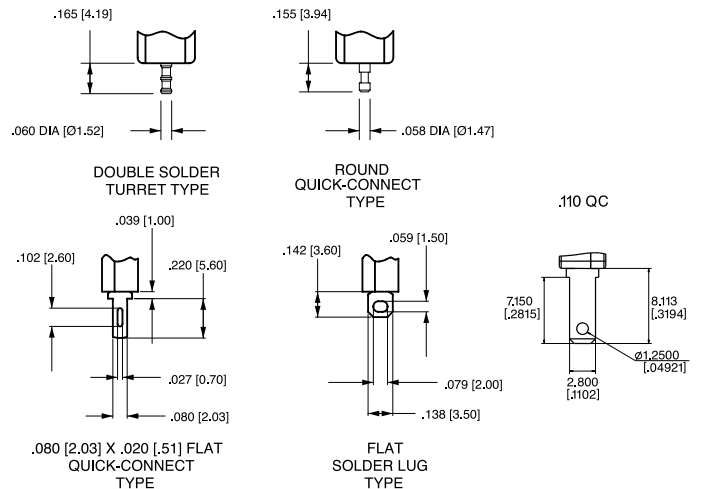

\*AVAILABLE THROUGH SPECIAL CATALOG PART NUMBER

## Dimensional Specifications: in. [mm]

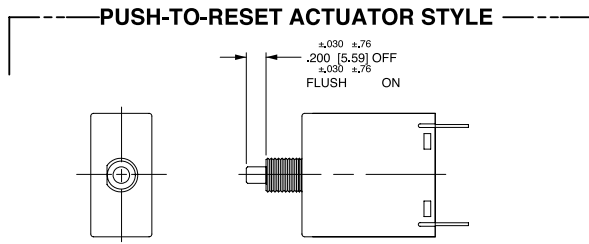
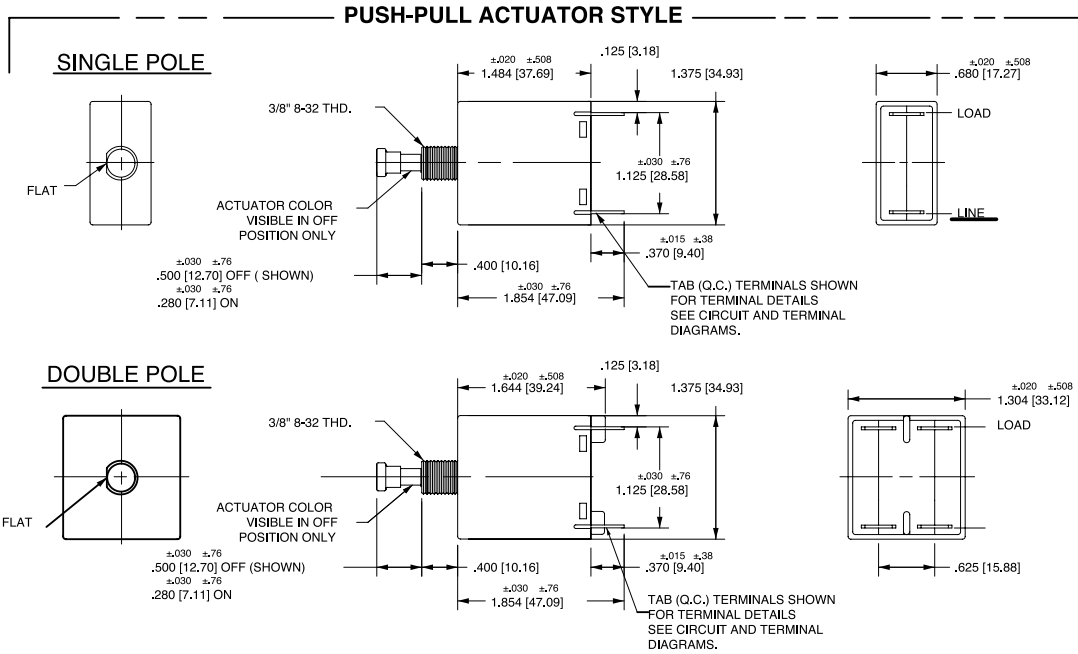

**MOUNTING DETAILS**

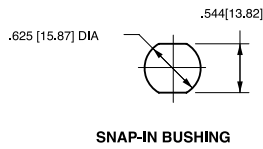
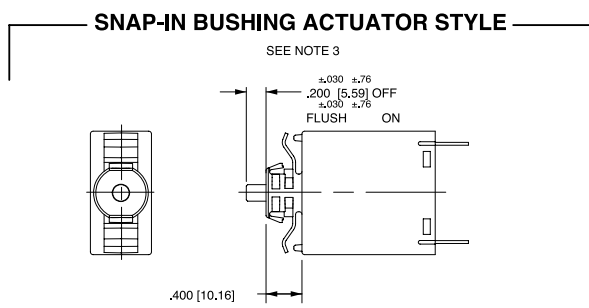
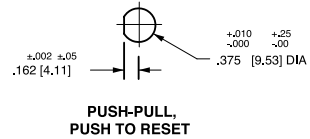

**PANEL HARDWARE**



**HEX NUT**

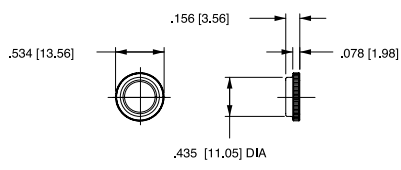

**PANEL DRESS NUT**

**BUTTON MARKING ORIENTATION (PUSH-PULL ONLY)**

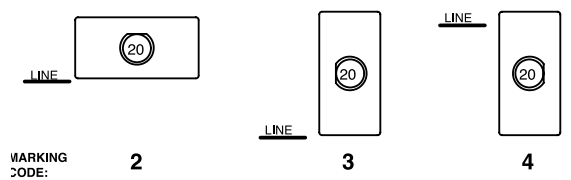

Notes:  
 1 All dimensions are in inches [millimeters].  
 2 Tolerance  $\pm 0.20$  [5.1] unless otherwise specified.  
 3 Available with Push-Pull or Push-to-Reset Actuators

## PC Terminal Diagrams: in. [mm]

### PUSH-PULLTYPE SHOWN WITHOUT AUX. SWITCH

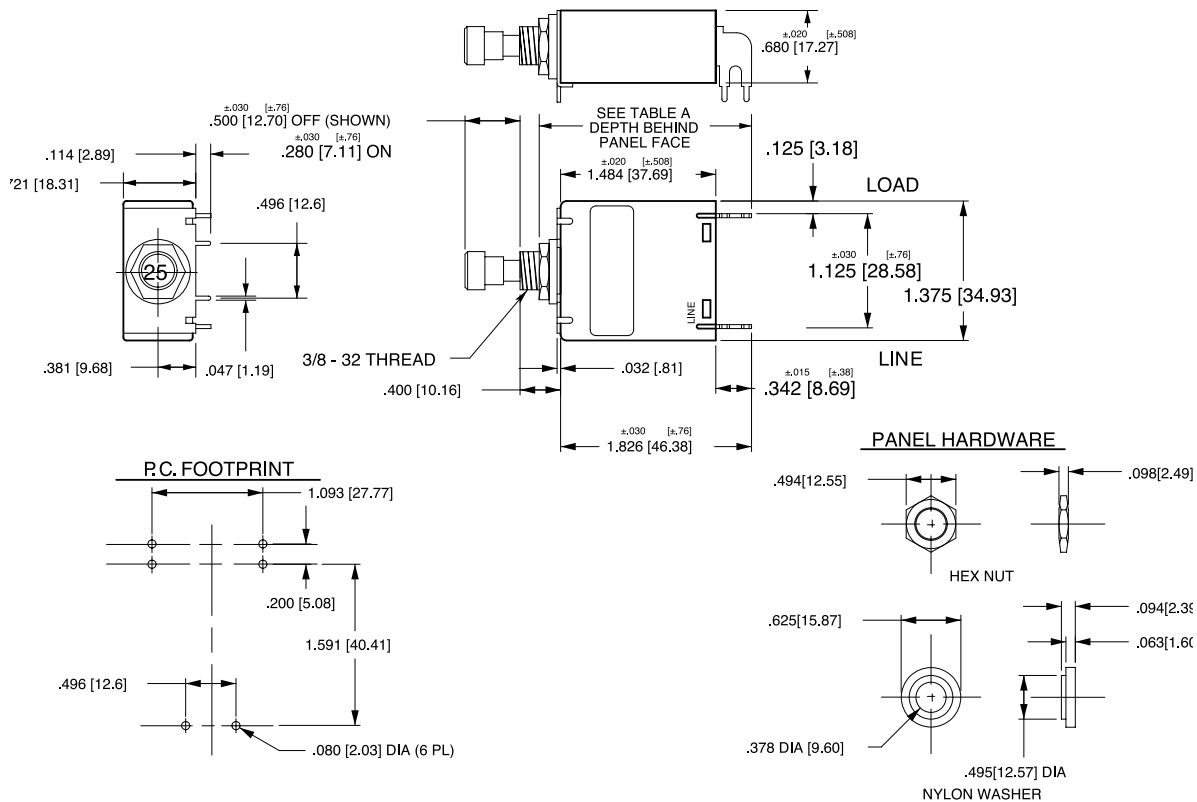

### PUSH PULL TYPE SHOWN WITH AUX. SWITCH

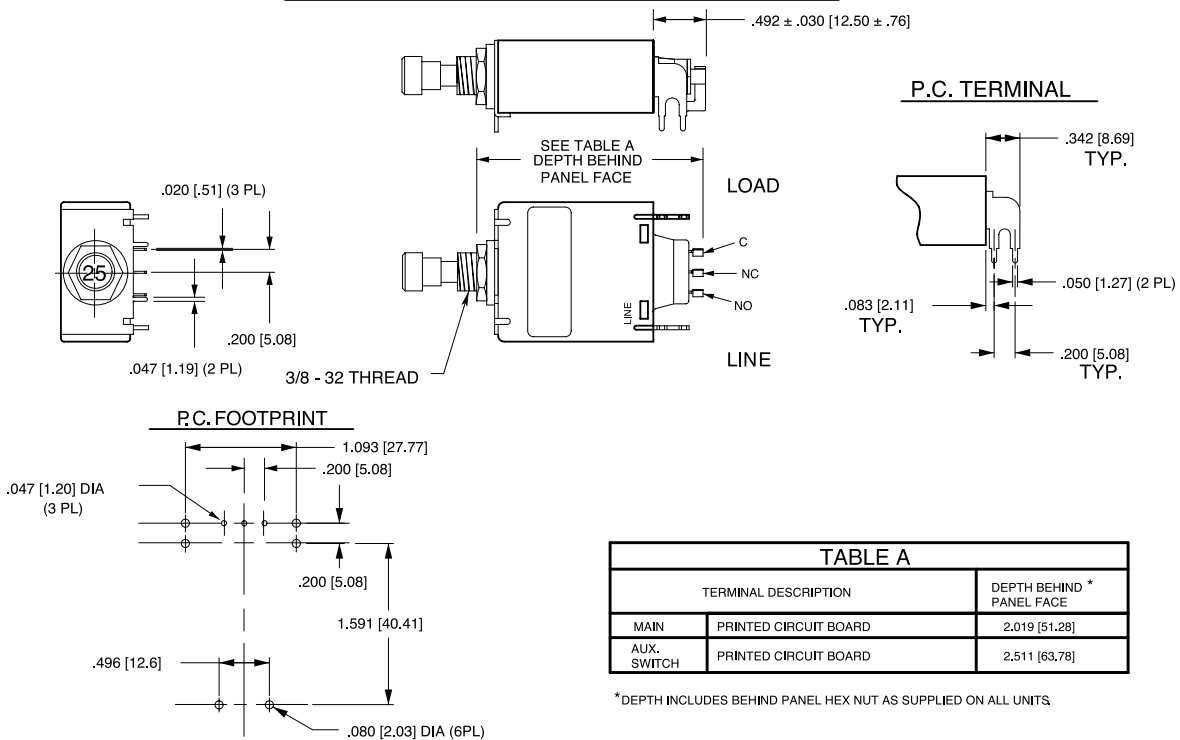

**Notes:**

- All dimensions are in inches [millimeters].
- Tolerance  $\pm 0.020$  [.51] unless otherwise specified.





**1 SERIES**  
M

**2 ACTUATOR<sup>1</sup>**  
**Non-Illuminated single color**  
**A** Angled  
**B** Flat  
**Two Color Visi-Rocker**  
**D** Indicate ON  
**E** Indicate OFF  
**Illuminated single color**  
**F** Angled  
**G** Flat

STYLE	INDICATE - "ON" (CODES A & D)	INDICATE - "OFF" (CODES B & E)	FLAT (CODES B & E)	ANGLED (CODES A & F)
VERTICAL				
HORIZONTAL				

**3 POLES**  
 1 One                      2 Two

**4 CIRCUIT<sup>2</sup>**  
**without Auxiliary Switch**  
**A** Switch Only (no coil), Maintained Contacts  
**B** Series Trip (Current)  
**with Auxiliary Switch, Silver Contacts**  
**M** Series Trip (Current) Aux Switch  
**P<sup>3</sup>** Switch Only, Maintained Contacts  
**Q<sup>3,4</sup>** Switch Only, Maintained Contacts  
**R<sup>3,16</sup>** Switch Only, Maintained Contacts  
**S<sup>3</sup>** Series Trip (Current)  
**T<sup>3,4</sup>** Series Trip (Current)  
**U<sup>3,16</sup>** Series Trip, Maintained Contacts  
**with Auxiliary Switch, Gold Contacts**  
**2<sup>3,4</sup>** Switch Only, Maintained Contacts  
**3<sup>3,16</sup>** Switch Only, Maintained Contacts  
**4<sup>3,4</sup>** Series Trip (Current)  
**5<sup>3,16</sup>** Series Trip, Maintained Contacts  
**9** Series Trip (Current) Aux Switch

**Terminal Type:**  
 .110 QC x .020 QC  
 .060 Dia, Round Solder Turret  
 .058 Dia, Round Q.C.  
 .080 Dia x .020 Flat Q.C.  
 .060 Dia, Round Solder Turret  
 .058 Dia, Round Q.C.  
 .080 Dia x .020 Flat Q.C.

**5 FREQUENCY & DELAY**  
**03** DC 50/60Hz, Switch Only      **32** DC, 50/60Hz Short  
**10** DC Instantaneous              **34** DC, 50/60Hz Medium  
**12** DC Short                          **62** 50/60Hz Short, Hi-Inrush  
**14** DC Medium                        **64** 50/60Hz Medium, Hi-Inrush  
**20** 50/60Hz Instantaneous        **72** DC, Short, Hi-Inrush  
**22** 50/60Hz Short                    **74** DC, Medium, Hi-Inrush  
**24** 50/60Hz Medium                **92** DC, 50/60Hz Short, Hi-Inrush  
**30** DC, 50/60Hz Instantaneous    **94** DC, 50/60Hz Medium, Hi-Inrush

VOLTAGE			FULL LOAD AMP RATING		GENERAL PURPOSE AMP RATING		TUNGSTEN LAMP RATING		POLES BREAKING
MAX. RATING	FREQUENCY	PHASE	MAX. AMPS	CHOOSE CURRENT COIL RATING CODE:	MAX. AMPS	CHOOSE CURRENT COIL RATING CODE:	MAX. AMPS	CHOOSE CURRENT COIL RATING CODE:	
32	DC	-	15	615	25	625	-	-	1
50	DC	-	-	-	7.5	Consult Factory	-	-	1
65	DC	-	15	615	25	625	-	-	2
125	50/60HZ	1	15	615	25	625	15	615	1
250	50/60HZ	1	12	612	-	-	-	-	1
250	50/60HZ	1	15	615	25	625	-	-	2

- Notes:  
 1 One actuator is located in the center of each multi-pole breaker.  
 2 For Switch Only circuits, select Current Coil Rating from the above chart.  
 3 One Auxiliary Switch is supplied per breaker. On two-pole breakers, standard Auxiliary Switch mounting is in pole one. Auxiliary Switch option limited to Series Trip & Switch Only circuits, & is not available in single pole illuminated breakers, or Back Connected Screw or Push-in Stud terminals.  
 4 Mates with AMP .058" diameter pin receptacles: 60983-1 (gold plated) & 60983-2 (tin plated).  
 5 For neon bulb applications at 120VAC @ 47K, 1/4 WATT and for 250VAC applications @ 150K, 1/4 WATT, external resistors must be supplied by customer.  
 6 On Visi-Rocker breakers, Visi portion of rocker cannot be the same color as the bezel.  
 7 For LED (DC or rectified AC) applications, LED is mounted in the center of the rocker actuator with electrical characteristics: 100 millicandela at 20mA; Maximum power dissipation = 75mW at 25°C; Maximum forward current = 25mA; Typical forward voltage = 2.1V at 20mA; Typical reverse current = 100uA at 3V. Customer supplies the proper external resistor limiting current to these values.  
 8 Rocker color for LED's and green neon lamp must be clear, smoke gray, white translucent or match color of LED or neon lamp.  
 9 Other colors available. Consult factory.  
 10 TUV 20A, VDE 15A. UL Recognized and CSA Accepted to 30 amps. Screw Terminals or Push-in Stud recommended above 20 amps.  
 11 TUV or VDE Certified must have I-O or Dual Legends.  
 Legend required on Visi-Rocker breakers.  
 12 30 amp rating not available with delay's 30, 32, 34, 92 or 94.  
 13 Screw Terminals are VDE certified only with use of ring terminal attached to wire.  
 14 Terminal code A available with circuit codes A & B only.  
 15 Printed circuit board available with UL recognized approval only.  
 16 Auxiliary switch (flat Q.C.) available with UL recognized approvals only.

**6 CURRENT RATING (AMPERES)**

CODE	AMPERES	CODE	AMPERES	CODE	AMPERES	CODE	AMPERES
020	0.020	225	0.250	420	2.000	710	10.500
025	0.025	230	0.300	522	2.250	611	11.000
030	0.030	235	0.350	425	2.500	711	11.500
035	0.035	240	0.400	527	2.750	612	12.000
040	0.040	245	0.450	430	3.000	712	12.500
045	0.045	250	0.500	435	3.500	613	13.000
050	0.050	255	0.550	440	4.000	614	14.000
055	0.055	260	0.600	445	4.500	615	15.000
060	0.060	265	0.650	450	5.000	616	16.000
065	0.065	270	0.700	455	5.500	617	17.000
070	0.070	275	0.750	460	6.000	618	18.000
075	0.075	280	0.800	465	6.500	620	20.000
080	0.080	285	0.850	470	7.000	622	22.000
085	0.085	290	0.900	475	7.500	624	24.000
090	0.090	295	0.950	480	8.000	625	25.000
090	0.095	410	1.000	485	8.500	630 <sup>12</sup>	30.000
210	0.100	512	1.250	490	9.000		
215	0.150	415	1.500	495	9.500		
220	0.200	517	1.750	610	10.000		

**7 TERMINAL**  
**1** Push-On 0.250 Tab (Q.C.)                      **A<sup>14</sup>** Push-In Stud  
**2<sup>10</sup>** Screw 8-32 with Upturned Lugs          **P<sup>15</sup>** Printed Circuit Board  
**3<sup>10</sup>** Screw 8-32 (Bus Type)

**8 ROCKER ILLUMINATION**  
**Non-Illuminated**  
**Neon<sup>5</sup>**  
 without resistor, 120VAC/250VAC  
**LED<sup>7,8</sup>**  
 without resistor  
 with resistor, 4-8 VDC  
 with resistor, 9-16 VDC

<b>A</b> Neon	Green Glow <sup>8</sup>	
<b>B</b> Red	Green	Amber
<b>D</b> Amber	Green	K
<b>E</b> White	Green	L
<b>F</b> Clear	Green	M

**9 ACTUATOR & LEGEND COLOR**

Solid Color	Actuator	Legend
1	White	Black
2	Black	White
3	Red	White
4	Green	White
5	Blue	White
6	Yellow	Black
7	Gray	Black
8	Orange	Black
<b>Visi-Rocker<sup>6</sup></b>	Visi & Legend (remainder of rocker same color as bezel)	
1	White	
2	Black	
3	Red	
4	Green	
5	Blue	
6	Yellow	
7	Gray	
8	Orange	
<b>Illuminated<sup>8</sup></b>	Actuator	Legend
<b>A</b>	Clear	White
<b>B</b>	Red Transparent	White
<b>C</b>	Green Transparent	White
<b>D</b>	Amber Transparent	White
<b>E</b>	Smoke Gray Transparent	White
<b>F</b>	White Translucent	Black

**10 LEGEND<sup>11</sup>**

1	No Legend	4	I - O Vertical
2	ON - OFF Vertical	5	I - O Horizontal
3	ON - OFF Horizontal	6	Dual Vertical
		7	Dual Horizontal

**11 BEZEL COLOR / STYLE<sup>9</sup>**

Color	without Rockerguard	with Rockerguard
White	<b>A</b>	1
Black	<b>B</b>	2
Gray	<b>G</b>	7

**12 AGENCY APPROVAL<sup>10</sup>**

<b>C</b>	UL Recognized & CSA Accepted
<b>D</b>	VDE Certified, UL Recognized & CSA Accepted
<b>E</b>	TUV Certified, UL Recognized & CSA Accepted



**1 SERIES**  
M

**2 ACTUATOR <sup>1</sup>**

**Non-Illuminated single color**  
A Angled  
B Flat

**Two Color Visi-Rocker**  
D Indicate ON  
E Indicate OFF

**illuminated single color**  
F Angled  
G Flat

STYLE	INDICATE "ON" (CODES A & D)	INDICATE "OFF" (CODES B & E)	FLAT (CODES B & G)	ANGLED (CODES A & F)
VERTICAL				
HORIZONTAL				

**3 POLES**  
1 One

**4 CIRCUIT <sup>2</sup>**

**without Auxiliary Switch**  
B Series Trip (Current)

**with Auxiliary Switch, Silver Contacts**  
M Series Trip (Current) Aux Switch  
S <sup>3</sup> Series Trip (Current)  
T <sup>3,4</sup> Series Trip (Current)  
U <sup>3,16</sup> Series Trip, Maintained Contacts

**with Auxiliary Switch, Gold Contacts**  
4 <sup>3,4</sup> Series Trip (Current)  
5 <sup>3,16</sup> Series Trip, Maintained Contacts  
9 Series Trip (Current) Aux Switch

**Terminal Type:**  
.110 QC x .020 QC  
.060 Dia, Round Solder Turret  
.058 Dia, Round Q.C.  
.080 Dia x .020 Flat Q.C.  
.058 Dia, Round Q.C.  
.080 Dia x .020 Flat Q.C.  
.110 QC x .020 QC

**5 FREQUENCY & DELAY**

10	DC Instantaneous	14	DC Medium
12	DC Short	72	DC, Short, Hi-Inrush
		74	DC, Medium, Hi-Inrush

**6 CURRENT RATING (AMPERES)**

CODE	AMPERES				
020	0.020	225	0.250	420	2.000
025	0.025	230	0.300	522	2.250
030	0.030	235	0.350	425	2.500
035	0.035	240	0.400	527	2.750
040	0.040	245	0.450	430	3.000
045	0.045	250	0.500	435	3.500
050	0.050	255	0.550	440	4.000
055	0.055	260	0.600	445	4.500
060	0.060	265	0.650	450	5.000
065	0.065	270	0.700	455	5.500
070	0.070	275	0.750	460	6.000
075	0.075	280	0.800	465	6.500
080	0.080	285	0.850	470	7.000
085	0.085	290	0.900	475	7.500
090	0.090	295	0.950	480	8.000
090	0.095	410	1.000	485	8.500
210	0.100	512	1.250	490	9.000
215	0.150	415	1.500	495	9.500
220	0.200	517	1.750	610	10.000

- Notes:
- One actuator is located in the center of each multi-pole breaker.
  - One Auxiliary Switch is supplied per breaker. Auxiliary Switch option limited to Series Trip & Switch Only circuits, and is not available in single pole illuminated breakers, or with Back Connected Screw or Push-in Stud terminals.
  - Mates with AMP .058" diameter pin receptacles: 60983-1 (gold plated) & 60983-1 (tin plated).
  - For neon bulb applications at 120VAC @ 47K, 1/4 WATT and for 250VAC applications at 150K, 1/4 WATT, external resistors must be supplied by customer.
  - For LED (DC or rectified AC) applications, LED is mounted in the center of the rocker actuator with electrical characteristics as follows: 100 millicandela at 20mA; Maximum power dissipation = 75mW at 25°C; Maximum forward current = 25mA; Typical forward voltage = 2.1V at 20mA; Typical reverse current = 100uA at 3V. Customer supplies the proper external resistor limiting current to these values.
  - On Visi-Rocker breakers, Visi portion of rocker cannot be the same color as the bezel.
  - Rocker color for LED's and green neon lamp must be clear, smoke gray, white translucent or match color of LED or neon lamp.
  - Other colors available. Consult factory.
  - UL Recognized, CSA Accepted and UL489A Listed to 30 amps. Screw Terminals recommended above 20 amps.
  - UL489A Listed must have ON-OFF or Dual legends. TUV Certified approvals must have I - O or Dual legends.
  - Terminal code A available with circuit codes A & B only.
  - Printed circuit board available with UL recognized approval only.
  - Auxiliary switch (flat Q.C.) available with UL recognized approvals only.

**7 TERMINAL**

1	Push-On 0.250 Tab (Q.C.)	A <sup>11</sup>	Push-In Stud
2	Screw 8-32 with Upturned Lugs	P <sup>12</sup>	Printed Circuit Board
3	Screw 8-32 (Bus Type)		

**8 ROCKER ILLUMINATION**

**Non-illuminated Neon <sup>4</sup>**  
without resistor, 120VAC/250VAC LED <sup>7, 8</sup>  
without resistor  
with resistor, 4-8 VDC  
with resistor, 9-16 VDC

A	Neon	Green Glow <sup>8</sup>
B	Red	Green
C		Amber
D		K
E		L
F		M

**9 ACTUATOR & LEGEND COLOR**

Solid Color	Actuator	Legend
1	White	Black
2	Black	White
3	Red	White
4	Green	White
5	Blue	White
6	Yellow	Black
7	Gray	Black
8	Orange	Black

**Visi-Rocker <sup>6</sup>** Visi & Legend (remainder of rocker same color as bezel)

1	White
2	Black
3	Red
4	Green
5	Blue
6	Yellow
7	Gray
8	Orange

**Illuminated <sup>7</sup>**

A	Clear	Legend White
B	Red Transparent	White
C	Green Transparent	White
D	Amber Transparent	White
E	Smoke Gray Transparent	White
F	White Translucent	Black

**10 LEGEND <sup>10</sup>**

1	No Legend (Single Color or Illuminated Rocker Options Only)
2	ON - OFF Vertical
3	ON - OFF Horizontal
4	I - O Vertical
5	I - O Horizontal
6	Dual Vertical
7	Dual Horizontal

**11 BEZEL COLOR / STYLE <sup>8</sup>**

Color	without Rockerguard	with Rockerguard
White	A	1
Black	B	2
Gray	G	7

**12 AGENCY APPROVAL <sup>9</sup>**

J	UL489A Listed & TUV Certified
M	UL Recognized & CSA Accepted
N	TUV Certified, UL Recognized & CSA Accepted
T	UL489A Listed

## Circuit & Terminal Diagrams: in. [mm]

### SERIES TRIP

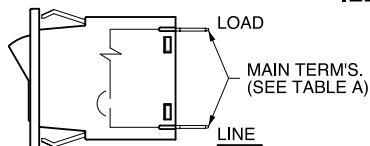

### SERIES TRIP W/ ILLUMINATED ROCKER

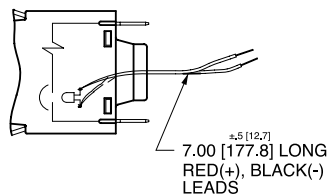

### SWITCH ONLY

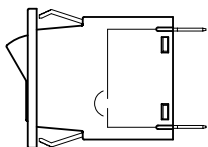

### SWITCH ONLY W/ ILLUMINATED ROCKER

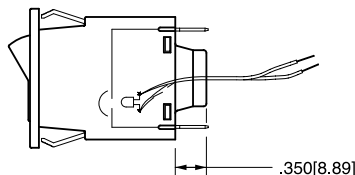

### SERIES TRIP W/ AUXILIARY SWITCH

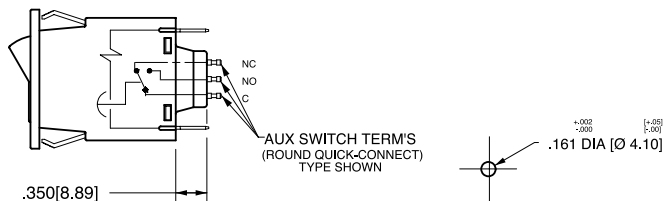

PUSH-IN STUD  
MATING HOLE

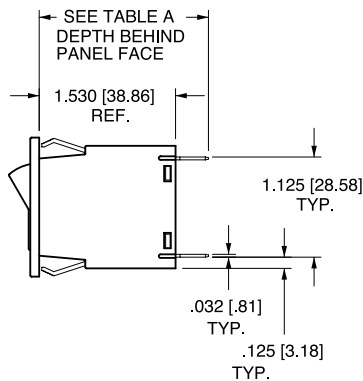

TABLE - A

TERMINAL DESCRIPTION		DEPTH BEHIND PANEL FACE
MAIN	TAB (Q.C.)	1.900 [48.26]
	SCREW (#8-32)**	1.940 [49.28]
	PUSH-IN STUD	2.530 [64.26]
*AUX. SWITCH	DOUBLE SOLDER TURRET TYPE	2.045 [51.94]
	ROUND Q.C. TYPE	2.035 [51.69]
	FLAT QUICK CONNECT	2.139 [54.33]
	FLAT SOLDER LUG	2.022 [51.36]

\* AUX. SWITCH IS NOT AVAILABLE ON SINGLE POLE ILLUMINATED UNITS. WHEN CALLED FOR ON MULTI-POLE UNITS, ONLY ONE AUX. SWITCH IS NORMALLY SUPPLIED, MOUNTED AS SHOWN ON CLA-8003.

\*\* RECOMMENDED TIGHTENING TORQUE 12-15 IN LBS [1.4-2.7 NM]

Notes:

- All dimensions are in inches [millimeters].
- Tolerance  $\pm .020$  [.51] unless otherwise specified.
- Schematic shown represents current trip circuit.

### TERMINAL DIMENSIONAL DETAIL

#### TAB (Q.C.) TERMINAL

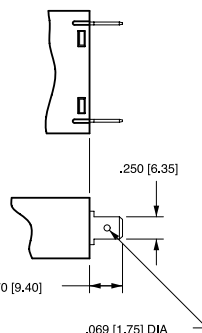

#### SCREW TERMINAL #8-32 WITH UPTURNED LUGS

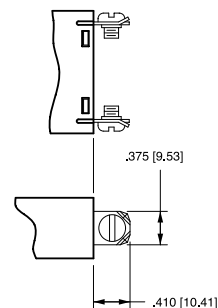

#### SCREW TERMINAL #8-32 BUS

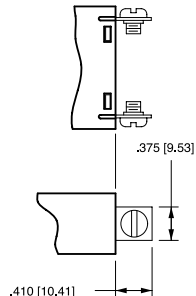

#### PUSH-IN STUD TERMINAL

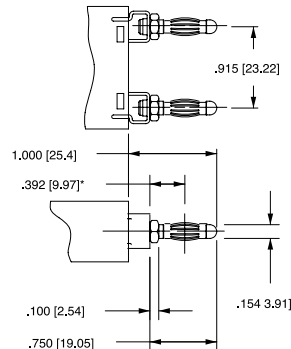

\*CENTERLINE OF  
PUSH-IN STUD  
CONTACT AREA

### AUXILIARY SWITCH TERMINALS

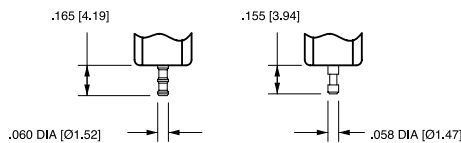

#### DOUBLE SOLDER TURRET TYPE

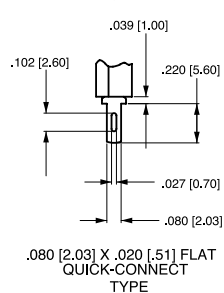

#### ROUND QUICK-CONNECT TYPE

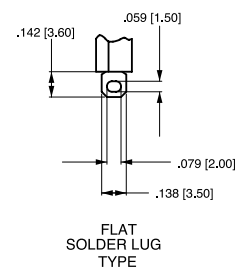

\*AVAILABLE THROUGH SPECIAL  
CATALOG PART NUMBER

#### .110 QC

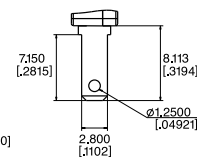

## Dimensional Specifications: in. [mm]

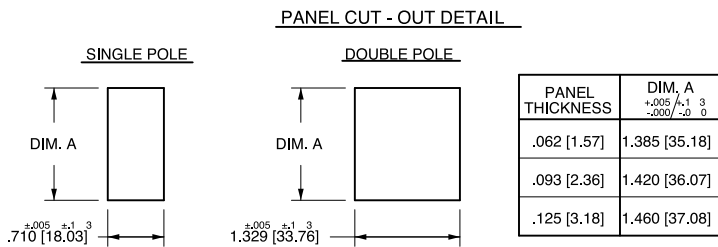
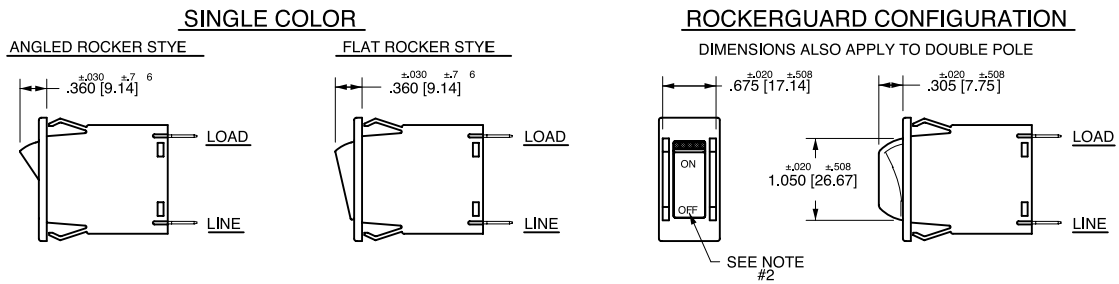
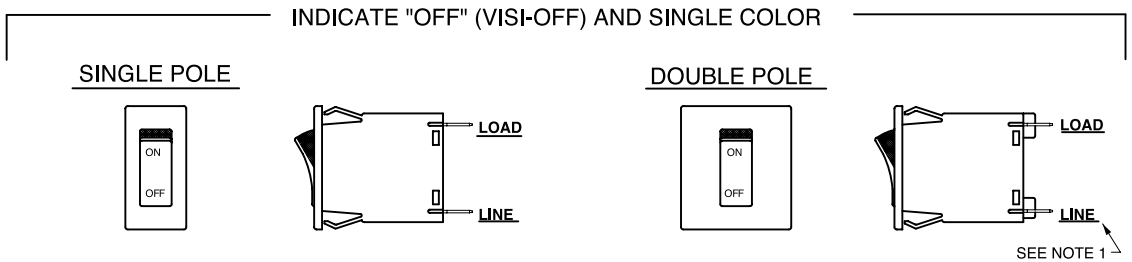
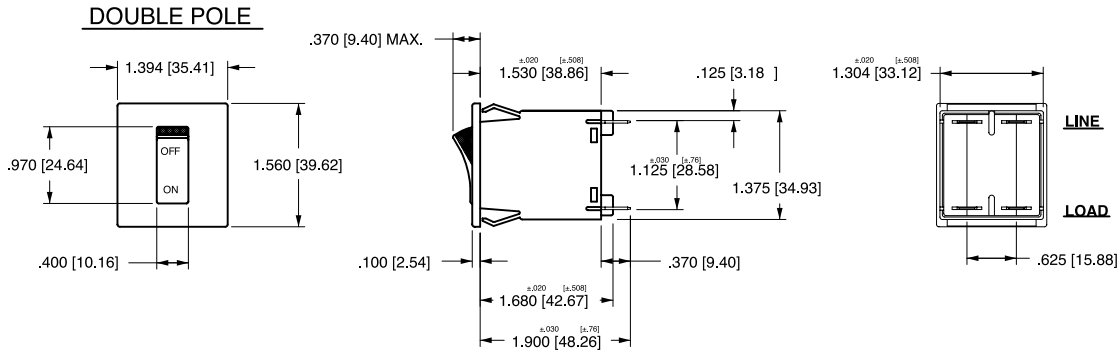
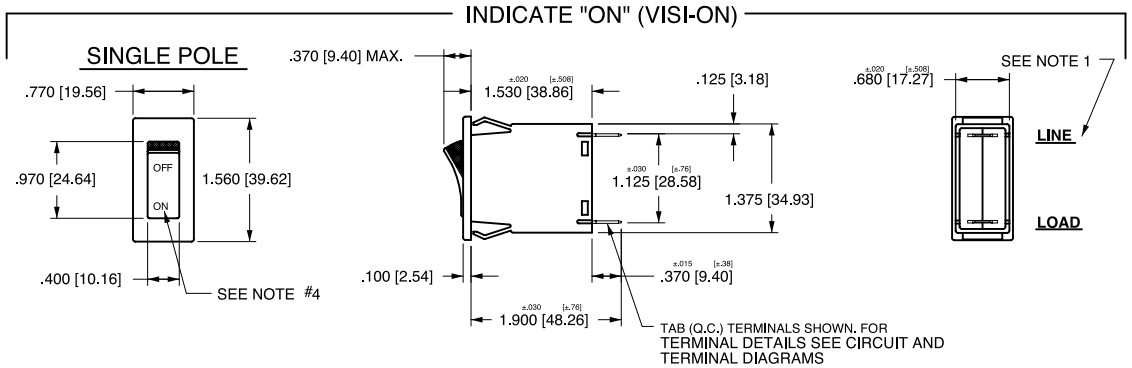

- Notes:
- Dimensions apply to all variations shown. Notice that circuit breaker line & load terminal orientation on indicate OFF is opposite of indicate ON.
  - I-O, ON-OFF or dual legends available for vertical or horizontal mounting. For pole orientation with horizontal legend, rotate front view clockwise 90°.
  - All dimensions are in inches [millimeters].
  - Tolerance ± 0.20 [.51] unless otherwise specified.

**ONE POLE**

**SINGLE POLE / ROCKER BREAKERS SHOWN WITH DOUBLE SOLDER TURRET AND ROUND QC AUX. SWITCH TERMINALS**

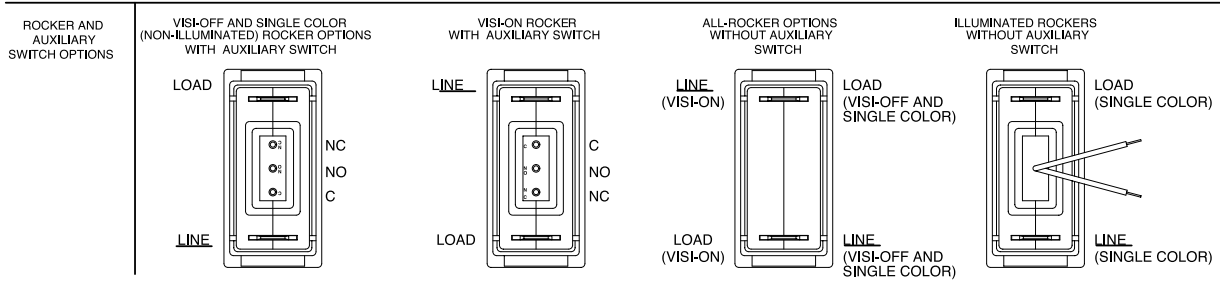

**SINGLE POLE / ROCKER BREAKERS SHOWN WITH FLAT QC AND FLAT SOLDER LUG AUX. SWITCH TERMINALS**

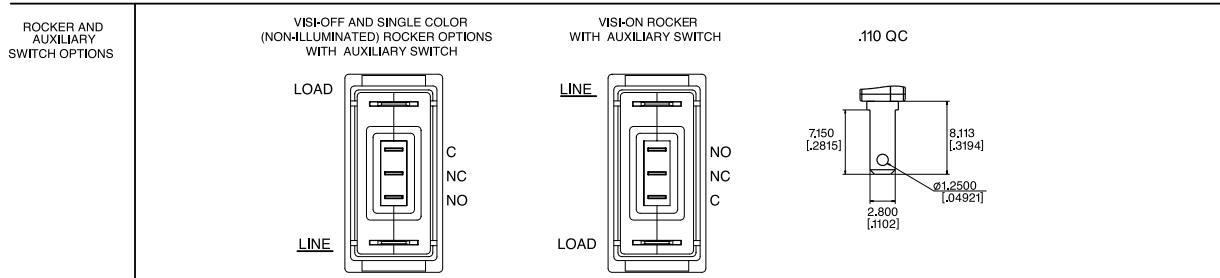

**TWO POLE**

**DOUBLE POLE / ROCKER BREAKERS SHOWN WITH DOUBLE SOLDER TURRET AND ROUND QC AUX. SWITCH TERMINALS**

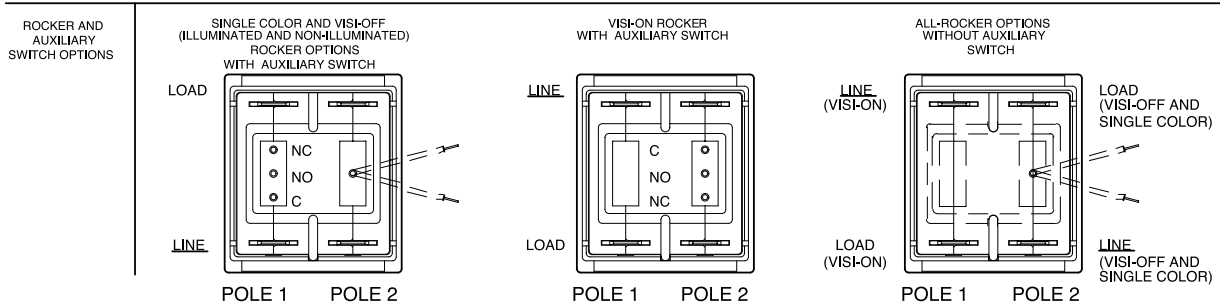

**DOUBLE POLE / ROCKER BREAKERS SHOWN WITH FLAT QC AND FLAT SOLDER LUG AUX. SWITCH TERMINALS**

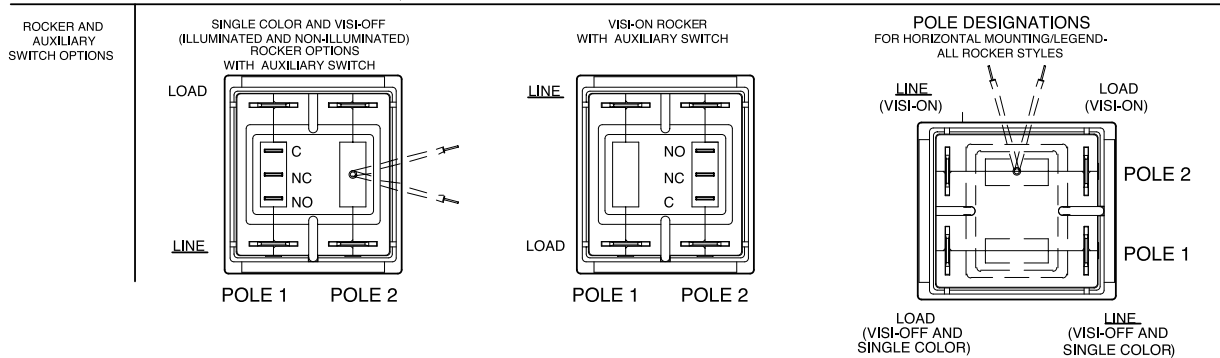

M, MS-SERIES TIME DELAY VALUES										
TRIP TIME SECONDS	PERCENT OF RATED CURRENT									
	Delay	100%	135%	150%	200%	400%	600%	800%	1000%	1200%
	10, 20, 30	No Trip	May Trip	.100 Max	.100 Max	.100 Max	.100 Max	.100 Max	.100 Max	.100 Max
12, 22, 32, 62, 72, 92	No Trip	.300 - 7.00	.200 - 5.00	.100 - 2.00	.030 - .500	.008 - .300	.006 - .150	.005 - .100	.005 - .100	.005 - .100
14, 24, 34, 64, 74, 94	No Trip	3.00 - 70.0	2.00 - 40.0	1.00 - 15.0	.100 - 4.00	.008 - 2.00	.006 - .800	.005 - .350	.005 - .160	

Notes:

- 1 Delay Curves 12,14, 22, 24, 32, 34, 62, 64, 72, 74, 92, 94: Breakers to hold 100% and must trip at 135% of rated current and greater within the time limit shown in this curve.
- 2 Delay Curves 10, 20, 30: Breakers to hold 100% and must trip at 150% of rated current and greater within the time limit shown in this curve.
- 3 All Curves: Curve data shown represents breaker response at ambient temperature of 77°F (25°C) with no preloading. Breakers are mounted in standard wall-mount position.
- 4 The minimum inrush pulse tolerance handling capability is 12 times the rated current on standard delays and 18 times the rated current on high inrush delays. These values are based on a 60 Hz 1/2 cycle, 8.33 ms pulse. High inrush delays should be specified for applications with high initial surge currents of short duration, such as switching power supplies, highly capacitive loads and transformer loads.

## Dual Rated AC/DC

### Instantaneous

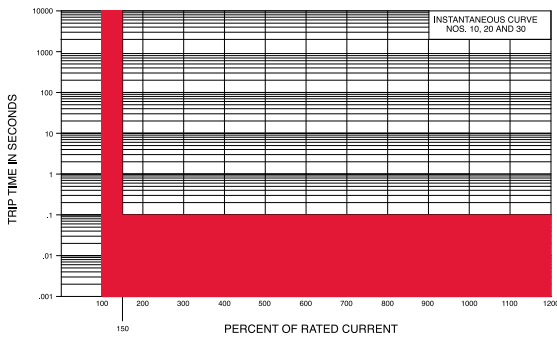

### Short

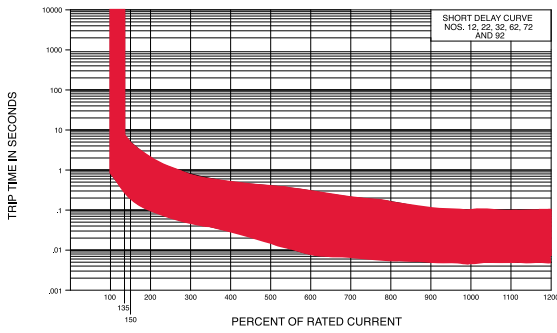

### Short D2

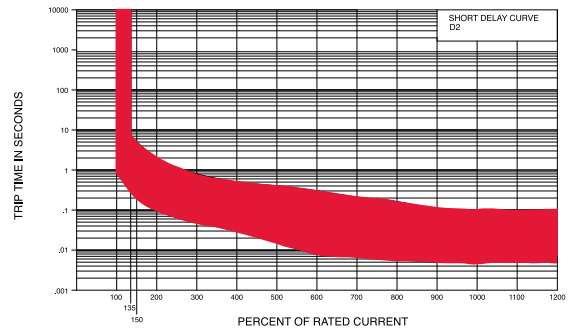

### Medium

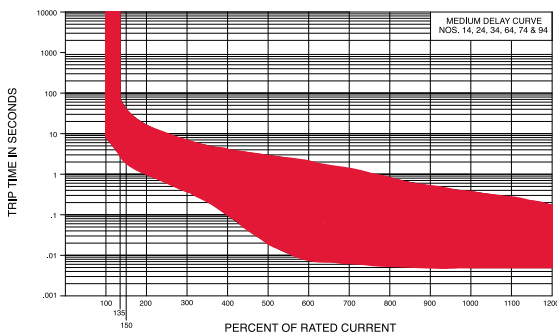

### Medium D4

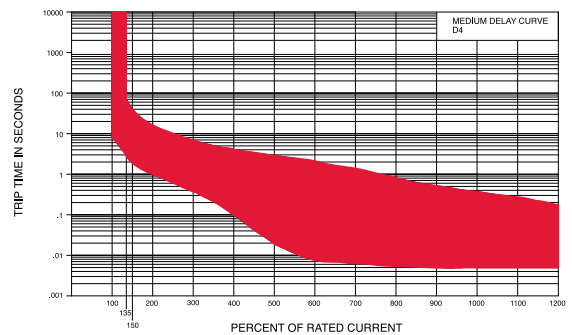

## Authorized Sales Representatives and Distributors

Click on a region of the map below to find your local representatives and distributors or visit [www.carlingtech.com/findarep](http://www.carlingtech.com/findarep).



## About Carling

Founded in 1920, Carling Technologies is a leading manufacturer of electrical and electronic switches and assemblies, circuit breakers, electronic controls, power distribution units, and multiplexed power distribution systems. With four ISO registered manufacturing facilities and technical sales offices worldwide, Carling Technologies Sales, Service and Engineering teams do much more than manufacture electrical components, they engineer powerful solutions! To learn more about Carling please visit [www.carlingtech.com/company-profile](http://www.carlingtech.com/company-profile).

To view all of Carling's environmental, quality, health & safety certifications please visit [www.carlingtech.com/environmental-certifications](http://www.carlingtech.com/environmental-certifications)

## **Worldwide Headquarters**

Carling Technologies, Inc.  
60 Johnson Avenue, Plainville, CT 06062  
**Phone:** 860.793.9281 **Fax:** 860.793.9231  
**Email:** sales@carlingtech.com

**Northern Region Sales Office:** nrsm@carlingtech.com  
**Southeast Region Sales Office:** sersm@carlingtech.com  
**Midwest Region Sales Office:** mrsms@carlingtech.com  
**West Region Sales Office:** wrsm@carlingtech.com  
**Latin America Sales Office:** larsm@carlingtech.com

## **Asia-Pacific Headquarters**

Carling Technologies, Asia-Pacific Ltd.,  
Suite 1607, 16/F Tower 2, The Gateway,  
Harbour City, 25 Canton Road,  
Tsimshatsui, Kowloon, Hong Kong  
**Phone:** Int + 852-2737-2277 **Fax:** Int + 852-2736-9332  
**Email:** sales@carlingtech.com.hk

**Shenzhen, China:** shenzhen@carlingtech.com  
**Shanghai, China:** shanghai@carlingtech.com  
**Pune, India:** india@carlingtech.com  
**Kaohsiung, Taiwan:** taiwan@carlingtech.com  
**Yokohama, Japan:** japan@carlingtech.com

## **Europe | Middle East | Africa Headquarters**

Carling Technologies LTD  
4 Airport Business Park, Exeter Airport,  
Clyst Honiton, Exeter, Devon, EX5 2UL, UK  
**Phone:** Int + 44 1392.364422 **Fax:** Int + 44 1392.364477  
**Email:** ltd.sales@carlingtech.com

**Germany:** gmbh@carlingtech.com  
**France:** sas@carlingtech.com



**Carling Technologies®**

Innovative Designs. Powerful Solutions.